

**SHARP®**

NOTEBOOK COMPUTER

**PC-UM20 Series**

**OPERATION MANUAL**

---

# Notice for Users in the USA

---

---

## FCC Statement

WARNING - FCC Regulations state that any unauthorized changes or modifications to this equipment not expressly approved by the manufacturer could void the user's authority to operate this equipment.

Note: This equipment has been tested and found to comply with the limits for a Class B digital device pursuant to Part 15 of the FCC Rules.

These limits are designed to provide reasonable protection against harmful interference in a residential installation. This equipment generates, uses and can radiate radio frequency energy and, if not installed and used in accordance with the instructions, may cause harmful interference to radio communications. However, there is no guarantee that interference will not occur in a particular installation. If this equipment does cause harmful interference to radio or television reception, which can be determined by turning the equipment off and on, the user is encouraged to try to correct the interference by one or more of the following measures:

- Reorient or relocate the receiving antenna.
- Increase the distance between the equipment and receiver.
- Connect the equipment into an outlet on a circuit different from that to which the receiver is connected.
- Consult the dealer or an experienced radio/TV technician for help.

A shielded I/F cable and included ferrite core for LAN cable is required to insure compliance with FCC regulation for Class B computing equipment.

\* As an ENERGY STAR® Partner, SHARP has determined that this product meets the ENERGY STAR® guidelines for energy efficiency.

## Declaration of Conformity

SHARP PERSONAL COMPUTER, PC-UM Series

This device complies with part 15 of the FCC rules. Operation is subject to the following conditions:(1) this device may not cause harmful interference, and (2) this device must accept any interference received, including interference that may cause undesired operation.

Responsible Party: SHARP ELECTRONICS CORPORATION  
Sharp Plaza, Mahwah, New Jersey 07430-2135  
TEL: 1-800-BE-SHARP

---

## About the Modem

This equipment complies with Part 68 of FCC rules. On the bottom of this equipment is a label that contains, among other information, the FCC registration number and ringer equivalence number (REN) for this equipment. If requested, this information must be provided to the telephone company.

The modem jack of this equipment complies with Sub-part F of Part 68 of FCC rules.

The REN is used to determine the quantity of devices which may be connected to the telephone line. Excessive RENs on the telephone line may result in the devices not ringing in response to an incoming call. In most, but not all areas, the sum of the RENs should not exceed five (5.0). To be certain of the number of devices that may be connected to the line, as determined by the total RENs contact the telephone company to determine the maximum REN for the calling areas.

If the terminal equipment causes harm to the telephone network, the telephone company will notify you in advance that temporary discontinuance of service may be required. But if advance notice isn't practical, the telephone company will notify the customer as soon as possible. Also, you will be advised of your right to file a complaint with the FCC if you believe it necessary.

The telephone company may make changes in its facilities, equipment, operations, or procedures that could affect the operation of the equipment. If this happens, the telephone company will provide advance notice in order for you to make the necessary modifications in order to maintain uninterrupted service.

If trouble is experienced with this equipment, please contact Sharp Electronics Corp. for repair and (or) warranty information (Refer to the end of this section). If the trouble is causing harm to the telephone network, the telephone company may request you remove the equipment from the network until the problem is resolved.

The equipment cannot be used on public coin service provided by the telephone company. Connection to Party Line Service is subject to state tariffs. (Contact the state public utility commission, public service commission or corporation commission for information.)

The Telephone Consumer Protection Act of 1991 makes it unlawful for any person to use a computer or other electronic device, including fax machines, to send any message unless such message clearly contains in a margin at the top or bottom of each transmitted page or on the first page of the transmission, the date and time it is sent and an identification of the business or other entity, or other individual sending the message and the telephone number of the sending machine or such business, other entity, or individual. (The telephone number provided may not be a 900 number or any other number for which charges exceed local or long-distance transmission charges.) To program this information, refer to the manual of the communication software.

---

## **Warning**

This product utilizes tin-lead solder, and fluorescent lamp containing a small amount of mercury.

Disposal of these materials may be regulated due to environmental considerations. For disposal or recycling information, please contact your local authorities or the Electronics Industries Alliance: [www.eiae.org](http://www.eiae.org)

---

## **Copyright**

It is the intent of Sharp that this product be used in full compliance with the copyright laws of the United States and that prior permission be obtained from copyright owners whenever necessary.

---

## **Product Information and Customer Assistance**

For Product Information and Customer Assistance:

**Call:** 1-800-BE-SHARP (237-4277)

**Sharp Systems of America**

5901 Bolsa Avenue, Huntington Beach, CA 92647



Home Page: <http://www.sharp-business.com>

E-mail address: [support@sharp-business.com](mailto:support@sharp-business.com)

---

# Notice for Users in the UK and Ireland

---

The mains lead of this product is fitted with a non-rewireable (moulded) plug incorporating a 3A fuse. Should the fuse need to be replaced, a BSI or ASTA approved BS 1362 fuse marked  or  and of the same rating as above; which is also indicated on the pin face of the plug must be used.

Always refit the fuse cover after replacing the fuse. Never use the plug without the fuse cover fitted.

In the unlikely event of the socket outlet in your home not being compatible with the plug supplied, cut-off the mains plug and fit an appropriate type.

## **DANGER:**

The fuse from the cut-off plug should be removed and the cut-off plug destroyed immediately and disposed of in a safe manner.

Under no circumstances should the cut-off plug be inserted elsewhere into a 13A socket outlet as a serious electric shock may occur.

To fit an appropriate plug to the mains lead, follow the instructions below:

## **IMPORTANT:**

The wires in the mains lead are coloured in accordance with the following code:

**Blue: Neutral**

**Brown: Live**

As the colours of the wires in the mains lead of this product may not correspond with the coloured markings identifying the terminals in your plug, proceed as follows:

- The wire which is coloured blue must be connected to the plug terminal which is marked N or coloured black.
- The wire which is coloured brown must be connected to the plug terminal which is marked L or coloured red.

Ensure that neither the brown nor the blue wire is connected to the earth terminal in your three pin plug.

Before replacing the plug cover, make sure that:

- If the new fitted plug contains a fuse, Its value is the same as that removed from the cut-off plug.
- The cord grip is clamped over the sheath of the mains lead and not simply over the lead wires.

**IF YOU HAVE ANY DOUBT, CONSULT A QUALIFIED ELECTRICIAN.**

## **Copyright**

Recording and playback of any material may require consent, which SHARP is unable to give. Please refer particularly to the provisions of the Copyright Act 1956, the Dramatic and Musical Performers Protection Act 1958, the Performers Protection Acts 1963 and 1972 and to any subsequent statutory enactments and orders.

---

# Notice for Users in Europe

---

## About the Modem

Your Sharp PC-UM series with integral modem has been designed to work with the analogue PSTN's in the following countries:

- United Kingdom
- Ireland
- Italy
- Germany
- Switzerland

If you wish to connect the equipment to the PSTN in a country not listed above, you should contact your equipment supplier for further details.

The modem is not designed for use on a shared service line or a line equipped with a call waiting facility. If you attempt to use the modem on a telephone line with call waiting, you may experience communication errors.

To maintain CTR21 network compatibility when used in the above listed countries the following setting should be observed:

Pulse dial may not be available in some countries.

Modem Name: T60M250.00

## Intended Use

This is a Personal Computer with Modem for the analogue PSTN network which operates in all UK, Irish, Italian, German, Swiss networks which follow the CTR21 Standard.

If you are in doubt whether your network follows the CTR21, please contact your dealer or network operator.

This equipment complies with the requirements of the Directive 1999/5/EC.

Dieses Gerät entspricht den Anforderungen der EU-Richtlinie 1999/5/EG.

Cet appareil est conforme aux exigences de la directive 1999/5/CE.

Este aparato satisface las exigencias de las Directiva 1999/5/CE.

Quest'apparecchio è conforme ai requisiti delle direttiva 1999/5/CE.

Dit apparaat voldoet aan de eisen van de richtlijn 1999/5/EG.

Este equipamento obedece às exigências da directiva 1999/5/CE.

Η συσκευή αυτή ανταποκρίνεται στις απαιτήσεις των οδηγία 1999/5/EK

Denna utrustning uppfyller kraven enligt direktiv 1999/5/EC.

Dette udstyr overholder kravene i direktiv 1999/5/EF.

Dette produktet oppfyller kravene i direktiv 1999/5/EC.

Tämä laite täyttää direktiivi 1999/5/EY.

---

## **About the battery**

Die gebrauchte Lithiumbatterie bitte gegen Kurzschluss sichern (z.B. durch Abkleben der beiden Batterie-Pole mit Klebestreifen) und der Verkaufsstelle zurückgeben.

Das Produkt enthält eine Lithiumbatterie. Die gebrauchte Lithiumbatterie bitte gegen Kurzschluss sichern (z.B. durch Abkleben der beiden Batterie-Pole mit Klebestreifen) und der Verkaufsstelle zurückgeben.



---

## **CAUTION:**

TO PREVENT ELECTRICAL SHOCK, DISCONNECT THE AC CORD AND THE BATTERY BEFORE SERVICING.

### **CAUTION:**

FOR A COMPLETE ELECTRICAL DISCONNECTION, PULL OUT THE MAIN PLUG AND THE BATTERY.

### **VORSICHT:**

UM DIE STROMZUFUHR VOLLSTÄNDIG ZU UNTERBRECHEN, DEN NETZSTECKER HERAUSZIEHEN UND DIE BATTERIE ENTFERNEN.

### **ATTENTION:**

POUR UN ARRÊT TOTAL DU SYSTÈME, DECONNECTEZ LA PRISE DE COURANT SECTEUR ET LA BATTERIE.

### **VARNING:**

FÖR TOTAL ELEKTRISK URKOPPLING, KOPPLA UR KONTAKTEN OCH TA UR BATTERIET.

### **PRECAUCION:**

PARA UNA COMPLETA DESCONEXION ELECTRICA DESENCHUFE LA CLAVIJA DE LA RED Y LA BATERIA.

---

# Safety Precautions

---

## General

- Follow all cautions and instructions, which may be marked, on the computer.
- Except as described elsewhere in this manual, refer all servicing to qualified personnel. Immediately shut off the computer and seek servicing under the following conditions:
  - when the power cord or plug is damaged or frayed
  - if liquid has been spilled on the computer
  - if the computer has been dropped or the cabinet has been damaged

## Location

- Do not expose the computer to direct sunlight.
- Try to avoid dusty environments.
- Keep the computer away from any magnetic devices and TVs.
- Keep the computer away from excessive humidity or fluids such as rain, snow, water spray, juice, coffee, steam, etc.
- Do not move the computer from an extremely cold place to an extremely warm place. A temperature difference of more than 10°C (18°F) will cause condensation inside the unit, which may cause damage.
- Do not block or cover slots or openings on the cabinet. These protect the computer from overheating.
- Care should be exercised when using on heat sensitive surfaces or your lap as the base of this computer will get hot.

## Usage

- Never push any objects of any kind into cabinet openings. They may touch dangerous voltage points or short parts that could result in fire or electrical shock.
- Turn off the computer before installing or removing a peripheral device (except when connecting USB devices and PC cards).
- Check the AC power cord and power connectors periodically for damage. Replace the power cord immediately if damage is found.
- Never subject your computer to sudden shocks or extreme vibration.

- Do not drop the computer nor hit it with other equipment.
- Do not scratch the surface of the LCD screen.
- Turn off the computer and disconnect the AC power cord before cleaning.

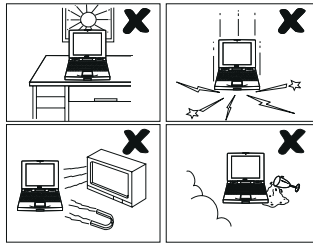

---

## Battery Pack Precautions

### CAUTION

DANGER OF EXPLOSION IF BATTERY IS INCORRECTLY REPLACED. REPLACE ONLY WITH THE SAME OR EQUIVALENT TYPE RECOMMENDED BY THE MANUFACTURER. DISCARD USED BATTERIES ACCORDING TO THE MANUFACTURER'S INSTRUCTIONS.

### Handling

- Never put the battery pack in a fire, as it could explode and cause injury.
- Do not attempt to open or alter the battery pack.
- Do not place the battery where it might get hotter than 60°C (140°F).
- Do not allow metal objects such as jewelry to short across the battery terminals, as it could heat up and explode.
- Do not allow liquids to come in contact with the battery pack.
- Avoid dropping the pack or other violent shock.
- Do not solder anything to the battery terminals.

### Charging

- Charge the battery pack only with the AC adapter included with your computer.

## **Discharging**

- Do not use the battery pack for any purpose other than powering the computer.

## **Storage**

- Store the battery pack in a cool and dry place. Never allow the temperature to exceed 60°C (140°F) during storage.
- Recharge the battery pack after storage, before use.

---

## **Modem Precautions**

- Never install telephone wiring during a lightning storm.
- Never install telephone jacks in wet locations unless the jack is specifically designed for wet locations.
- Never touch uninsulated telephone wires or terminals unless the telephone line has been disconnected at the network interface.
- Use caution when installing or modifying telephone lines.
- Avoid using the telephone during a lightning storm. There may be a remote risk of electric shock from lightning.
- Do not use the telephone to report a gas leak while in the vicinity of the leak.

---

# About This Manual

---

## Notice

Information in this manual is subject to change without notice and does not represent a commitment on the part of SHARP Corporation.

SHARP Corporation shall not be liable for technical or editorial errors or omissions contained herein; nor for incidental or consequential damages resulting from the furnishing, performance, or use of this material.

SHARP strongly recommends that separate permanent written records be kept of all important data. Data may be lost or altered in virtually any electronic memory product under certain circumstances. Therefore, SHARP assumes no responsibility for data lost or otherwise rendered unusable whether as a result of improper use, repairs, defects, battery replacement, use after the specified battery life has expired, or any other causes.

SHARP assumes no responsibility directly or indirectly, for financial losses or claims from third persons resulting from the use of this product and any of its functions, such as stolen credit card numbers, the loss of or alteration of stored data, etc.

## Edition

1st Edition, February 2002.

## Copyright

© 2002 SHARP Corporation

This document contains or refers to proprietary information which is protected by copyright. All rights are reserved. Copying or other reproduction of this document is prohibited without the prior written permission of SHARP Corporation.

## Trademarks

Pentium is a registered trademark of Intel Corporation.

IBM is a trademark of International Business Machines Corporation.

Microsoft, MS-DOS, Windows, and the Windows Logo are registered trademarks of Microsoft Corporation.

All other brand and product names are trademarks or registered trademarks of their respective holders.

---

# Recording Important Information

---

For future reference, please record the following information in the spaces provided below.

**Model Number:**

**Serial Number:**

**Date of purchase:**

**Dealer's Name:**

**Place of purchase:**

**Password:**

The serial number is printed on a sticker located on the bottom of the computer.

---

# Manual Conventions

---

This manual uses a set of style conventions described below.

**Notes and Cautions** are italicized with icons:



*A note icon informs you of a special technique or information that may help you perform a task or better understand a process.*



*A caution icon alerts you to something that may cause problems or damage to hardware, software or data.*

---

**Key Labels on the Keyboard**, when referred to in the instructions, are shown in boldface:

Press **Enter** to continue.

When two or more keys are pressed simultaneously, the key labels are separated by a plus (+) sign:

Restart your computer by pressing **Ctrl+Alt+Delete**.

**Sample Entries** are shown in upper cases of different typeface.

C: \WINDOWS\SYSTEM

**Words/Texts on Screen**, such as window titles or possible parameters, are italicized:

Double-click this icon to display the *Power Properties* window.

Set the item to *Enabled*.

**Screens** reproduced in this manual may differ slightly from the screens you see on your computer.

**Section Titles** in other parts of this manual are italicized:

Refer to *Installing Battery Pack* section in Chapter 1.

---

# Table of Contents

---

Notice for Users in USA.....	i
Notice for Users in the UK and Ireland.....	iv
Notice for Users in Europe.....	vi
Safety Precautions.....	ix
About This Manual.....	xii
Recording Important Information.....	xiii
Manual Conventions.....	xiv
Table of Contents.....	xv
Overview of Computer.....	xvii

---

## Quick Setup

Installing Battery Pack.....	1-1
Connecting AC Power.....	1-3
Setting Up Windows.....	1-5
Turning Off Your Computer.....	1-8

---

## Basic Operations

Choosing Power Source.....	2-1
Resetting the System.....	2-3
Using the Glide Pad.....	2-4
Using the Keyboard.....	2-6
Sharing the Computer (Windows 2000).....	2-8
Sharing the Computer (Windows XP Professional).....	2-9

---

## Battery and Power Management

Battery Pack.....	3-1
Optional High Capacity Battery Pack.....	3-7
Power Management.....	3-8

---

## Peripherals

Using Peripherals.....	4-1
Using Optional External Floppy Disk Drive Unit.....	4-3
Using Optional External CD-ROM Drive Unit.....	4-6
Display.....	4-12
Audio System.....	4-15



USB Device.....	4-17
PC Card.....	4-17
Printer.....	4-21
Using the Optional Port Bar.....	4-21

---

## Communication Functions

Built-in Modem.....	5-1
LAN unit.....	5-5

---

## Setup Utility

Running the Setup Utility.....	6-1
Main Menu.....	6-3
Advanced Menu.....	6-4
Security Menu.....	6-5
Exit Menu.....	6-7

---

## Appendixes

Converting File Format.....	A-1
Maintenance and Care.....	A-2
Re-installation Instructions.....	A-4
Specifications.....	A-9

---

## Troubleshooting

---

## Index

---

# Overview of Computer

---

Each number after an arrow indicates the page referring to the part. Actual appearance of your computer may be slightly different depending on the model.

---

## Front

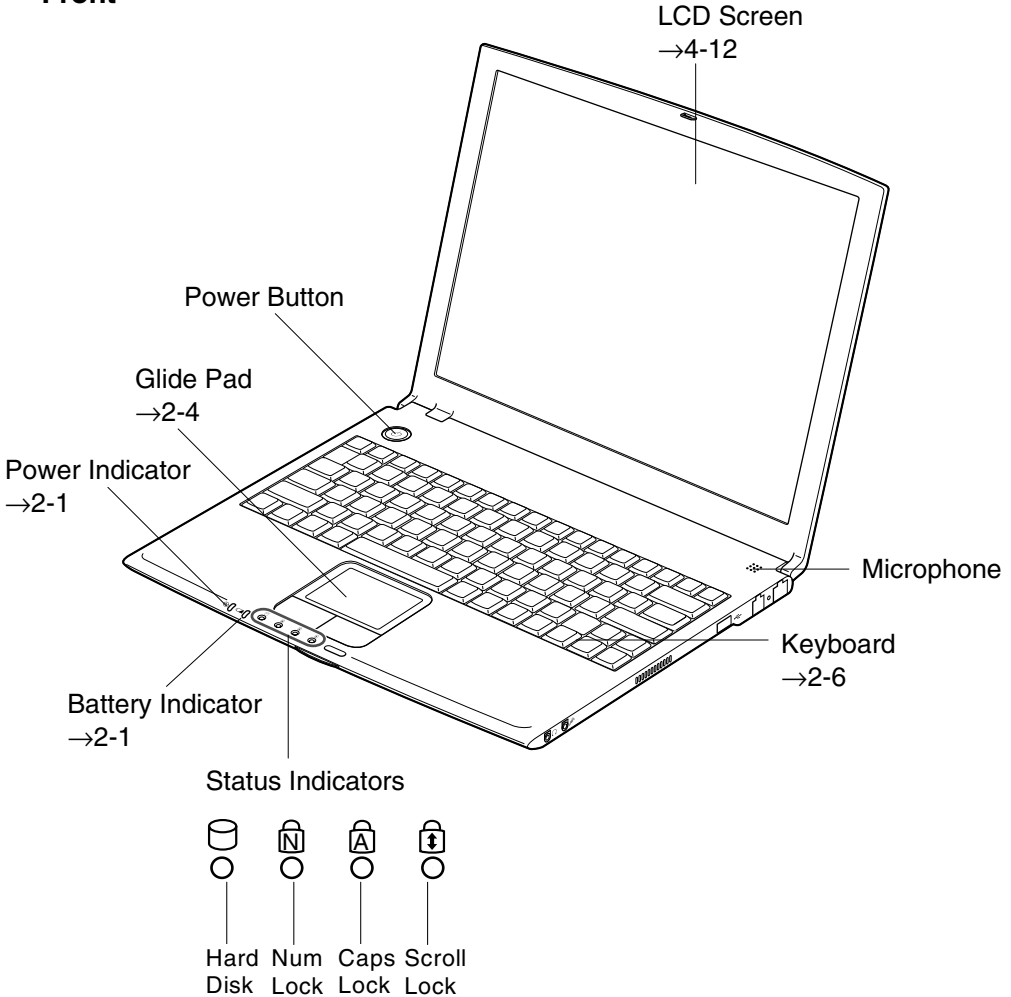

---

## Right

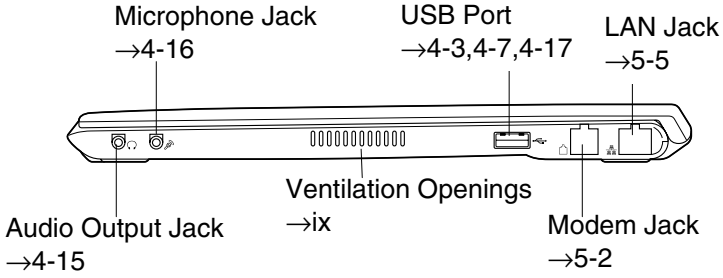

---

## Left

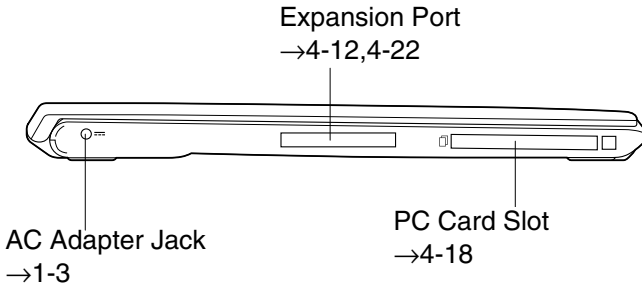

---

## Bottom

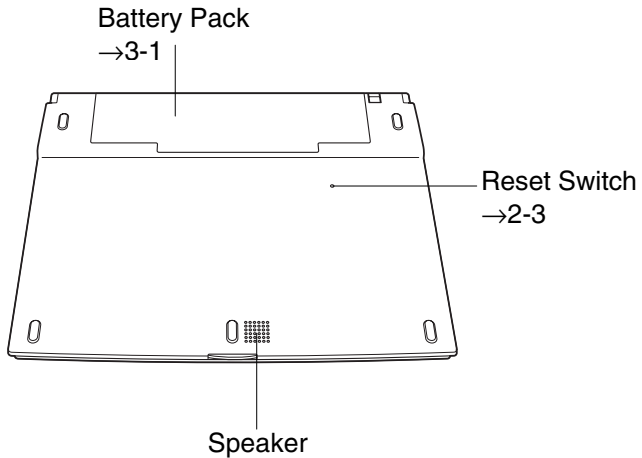

## Quick Setup

Your computer is designed and pre-configured for easy setup and use. This chapter describes the steps to get your computer up and running as quickly as possible. Read this chapter first.

---

### Installing Battery Pack

---

Your computer is powered with either the rechargeable battery pack or AC power. See the next chapter for more information on power sources. Before using the computer for the first time:

1. Place the computer upside down.

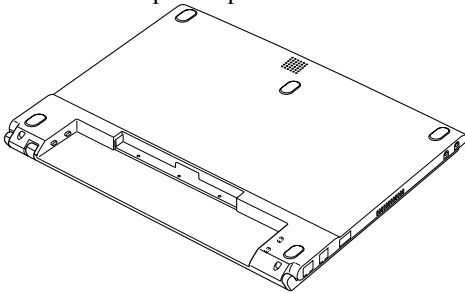

2. Slide the battery stopper on the battery pack to the unlocked position (a).

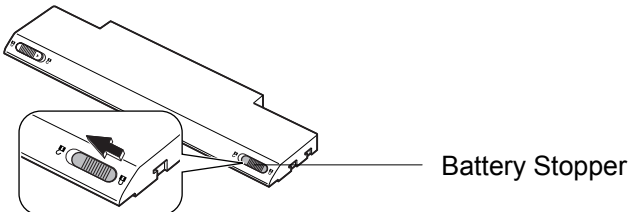

3. Insert the battery pack into the computer by matching the notched parts of the battery to the projected parts on the computer.

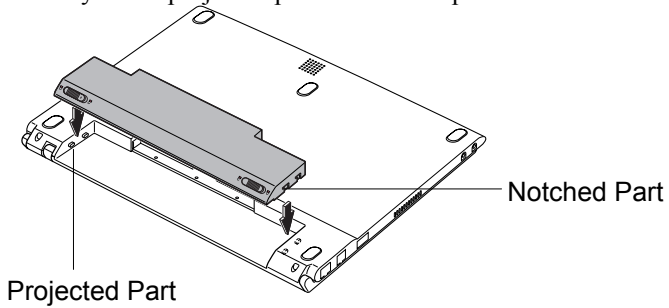

4. Push the battery pack until you hear the clicking sound.

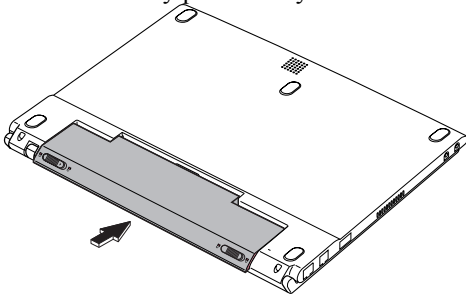

5. Slide the battery stopper to the locked position (🔒).

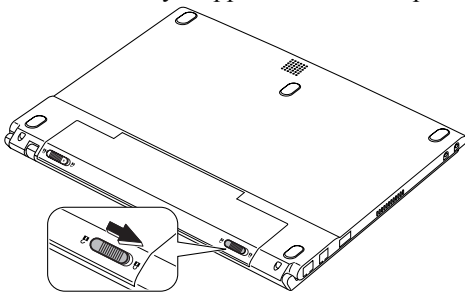

6. Turn over your computer and go to the next section.

---

# Connecting AC Power

---

1. Plug the AC adapter cable to the AC adapter jack on the left side of your computer.
2. Plug the AC power cord into the AC adapter.
3. Plug the AC power cord into a wall outlet.

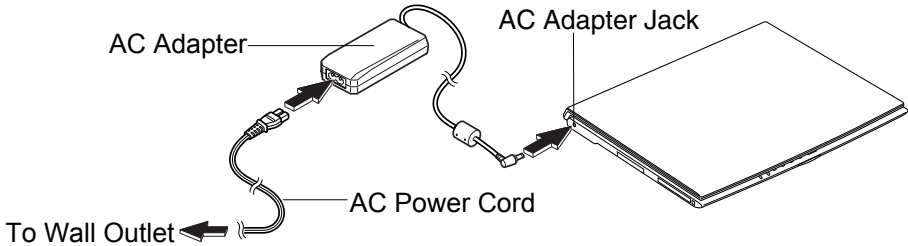

- *Always use the AC adapter included with the computer or the optional one (may not be available in some countries). Using other AC adapters may damage the computer.*
- *Always hold the AC power cord by its plug when removing it from the wall outlet. Never pull on the cord.*
- *When using the computer for the first time, be sure to connect it to AC power. If using the battery instead, you may not be able to complete the Windows setup if the battery does not have enough power.*

4. Press the display cover lock button until the display cover releases, and raise the cover.

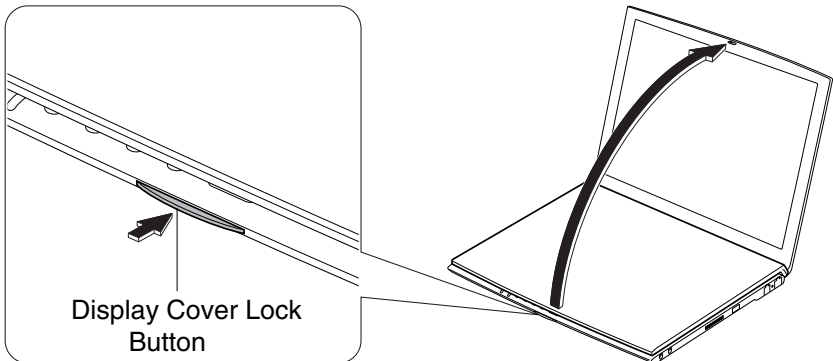

5. Tilt the cover to more than 90-degrees.

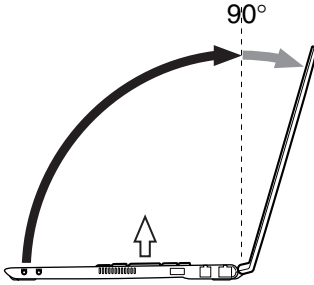

- *The keyboard of your computer will raise automatically when you open the display cover. You need to tilt the cover more than 90-degrees to raise the keyboard completely. Otherwise the keyboard or the computer may malfunction.*

6. Press the power button to turn on your computer.

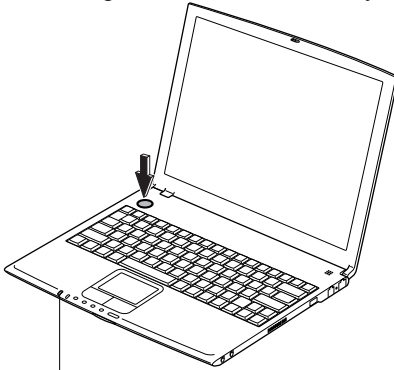

Power Indicator

When you turn on the computer, the power indicator (  ) turns green, the computer goes through a self test to detect any problems, and Windows setup process starts. See the next page.

---

# Setting Up Windows

---

Before starting the setup of Windows, you must select the operating system. There are two kinds of operating system available: Windows 2000 and Windows XP Professional. You can choose one of them when starting to use the computer for the first time.

If you choose Windows 2000, the setup steps are:

- Accepting license agreement
- Configuring the name of you and your organization
- Configuring the setting of your computer within the work group
- Completing configuration

If you choose Windows XP Professional, the setup steps are:

- Configuring your location, language and keyboard
- Configuring your time zone
- Accepting license agreement
- Naming your computer
- Registering your computer
- Creating an account
- Completing configuration

To setup Windows, follow the instructions on the screen. See also the Windows manual. It takes approximately 15-20 minutes to complete the entire setup process.



- *Do not turn off the computer until completing Windows setup. If you turn it off, you cannot set up Windows later.*
  - *Be sure to connect the computer to AC power. If using the battery instead, you may not be able to complete the Windows setup if the battery does not have enough power.*
  - *Do not connect any peripheral devices to your computer unless Windows setup completes. Otherwise your computer may malfunction.*
-





- *If the display turns off, some power management may function. In this case, press any key to resume your computer from the power management.*
- *If you cannot operate the keyboard or the touch pad, press the power button for more than four seconds to turn off the computer. Be sure that the battery indicator turns off; then, after more than 10 seconds, press the power button to turn it on again.*

## **For Users Outside UK**

After completing Windows setup, set your date and time. Double-click the time appearing on the right of the taskbar to open *Date/Time Properties* (Windows 2000) or *Date and Time Properties* (Windows XP Professional) dialog box. Confirm *Time Zone* is correctly selected, and set date and time.

## **For UK Users**

After completing Windows setup, double-click *README FIRST* (for U.K.users) icon on the desktop and follow the instructions in it to customize the setting suitable for UK users. Then set date and time in *Date/Time Properties* (Windows 2000) or *Date and Time Properties* (Windows XP Professional) dialog box.

## **Properties Dialog Box in Windows 2000**

In the instructions in this manual, you will often see the expression “XXX Properties dialog box.” A dialog box is a window containing text boxes, check boxes, buttons, etc., with which you can send commands to Windows or other application programs. To open the properties dialog boxes, click the *Start* button to open the *Start* menu; then, select *Settings - Control Panel* and double-click the XXX icon. Some of the dialog boxes you will use often are:

- Display
- Phone and Modem Options
- Mouse
- Power Options
- System

## **Properties Dialog Box in Windows XP Professional**

To open the properties dialog boxes, click *start - Control Panel*. There are two types of view for the *Control Panel*. One is Category view, and the other is Classic view. If you select Category view, you can choose the category which may be related to what you want to do, then, choose your task by clicking it. If Classic view selected, all the icons appear simultaneously. You can open a property dialog

box, or similar window, for the component or feature represented by that icon, by double-clicking it.

---

# Turning Off Your Computer

---

When you're finished using your computer, turn it off with the following ways:

- With a power button (Windows 2000)  
Before using this way, confirm that *Power Off* is selected in *When I press the power button on my computer* in *Advanced* tab of *Power Options Properties* dialog box.
- With a power button (Windows XP Professional)  
Before using this step, confirm that *Shut down* is selected in *When I press the power button on my computer* in *Advanced* tab of *Power Options Properties* dialog box.
- From the Start menu (Windows 2000)
  1. From the *Start* menu, select *Shut Down*....
  2. In the *Shut Down Windows* dialog box, select *Shut down* from the pull down menu, and click *OK*.
- From the start menu (Windows XP Professional)
  1. Click *start – Turn Off Computer*.
  2. In the *Turn off computer* dialog box, click *Turn Off*.

Close the cover to keep the screen and keyboard clean and protected.



*If you have not saved a file, a dialog box will appear asking whether you want to save it.*



- *Do not turn off or reset the computer while the hard disk indicator, or the indicator on the optional external floppy disk drive unit, or optional external CD-ROM drive unit are lit. Doing so may damage or even wipe out the data.*
  - *Before turning it back on, wait at least ten seconds after turning off the computer. Turning the power off and on in rapid succession can damage the computer's electrical circuitry.*
-

## Basic Operations

This chapter describes the basic operations of your computer.

---

### Choosing Power Source



---

You can use the computer with one of the following power sources:

- AC power from a wall outlet  
Use AC power whenever possible; rely on the battery only when AC power is not available.
- Rechargeable battery  
Your computer is equipped with a standard battery. You can also use an optional battery. See Chapter 3 for battery information.

#### About the Power Indicators

The following indicators show the power status of your computer.

Indicator	Light	Meaning	
Power 	On (green)	Operating	
	Blinking (green)	In System Standby	
	Off	Powered off or in System Hibernate	
Battery 	When Connected to AC Power	On (green)	Fully charged
		On (orange)	Being charged
		Blinking (orange)	In abnormal state. Remove the battery pack and install it again.
	When Run by Battery	Off	Has power
		On (red)	Almost completely discharged (The warning beep sounds)

Battery indicator is always off when the computer is turned off and not connected to AC power.



- *When the battery is hot, the battery indicator may turn off and stay off until the battery becomes cool.*
- *For more information on System standby/hibernate, see Chapter 3.*

---

## Using the AC Adapter

When connected to a wall outlet, the AC adapter provides power for operation and charges the battery. The AC input voltage can range from 100 to 240 volts so that you can use the computer with the appropriate plug adapter.



*The AC power cord included with the computer is appropriate for the voltage used in the area in which you purchased your computer. If you attempt to connect the computer to a wall outlet other than in this area, check the voltage of the outlet and use an AC power cord appropriate for the outlet. Consult local service staff if you are unsure.*

---

# Resetting the System

---

You may need to restart the system if the computer becomes unoperable or after adding new hardware or software. When the message appears after the installation, click *OK*, *Yes*, etc. to restart Windows.

You can also restart Windows 2000 from the *Start* menu. Select *Shut down...*; then, *Restart*. You can restart Windows XP Professional by clicking *start - Turn Off Computer*; then, *Restart*.

---

## Warm Boot (Software Reset)

If the system is locked up because of a software problem, you can reset or reboot the system by pressing the **Ctrl+Alt+Del** keys simultaneously and follow the instructions on the screen.



*Resetting may cause data loss. Use the resetting process only if the normal Windows Shut Down does not work because of software malfunction. Although resetting will not damage the system, you may lose the data you are processing.*

---

---

## Power Switch

You can turn off the computer with the power button if you encounter hardware or software problems which lock up the system. In this case, press the power button for more than four seconds.

---

## Reset Switch

If you cannot turn off the computer by pressing the power button, you can use the reset switch on the bottom of your computer. To reset the system, insert a narrow object into the small hole to press the switch.

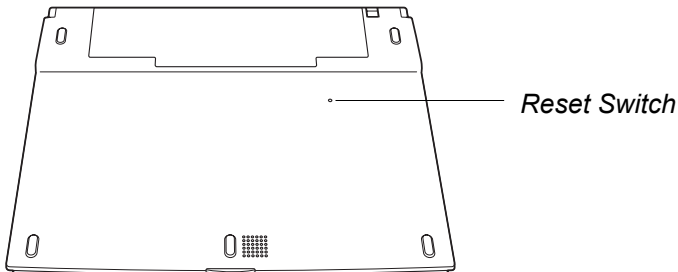

---

# Using the Glide Pad

---

Your computer is equipped with an integrated pointing device called a glide pad. Using the glide pad, you can move the pointer, select an item from a menu, and perform other tasks in the same way you would with a mouse.

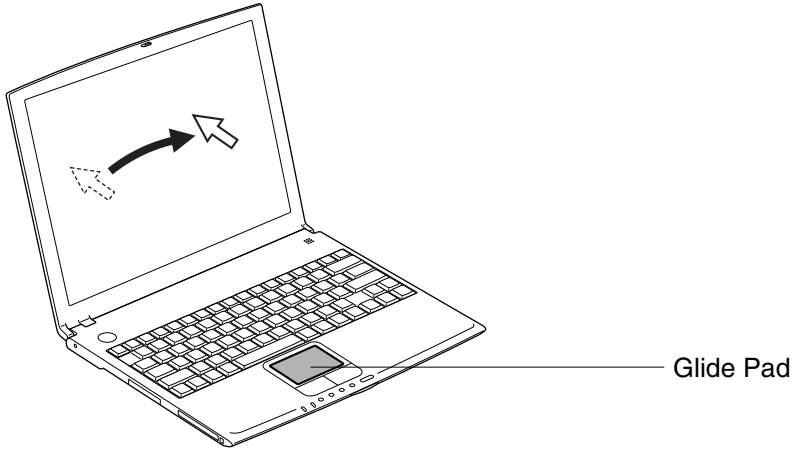

- *Do not hit or scratch the surface of the glide pad with pointed objects (such as a ballpoint pen).*
- *Do not operate the glide pad with a moist finger. This may cause the glide pad to operate incorrectly.*

---

## Using the Glide Pad

Take a moment to become familiar with how the glide pad works.

### Place Your Fingertip

Place your left or right hand next to the glide pad, resting your wrist naturally in a relaxed manner. Place your thumb or finger on the glide pad.

### Move Your Fingertip

The rectangular pad of the glide pad acts like a miniature duplicate of the display. As you slide your fingertip across the pad, the pointer on the screen moves in the same direction across the screen. The glide pad is very sensitive, so you do not

have to exert much pressure on the pad. The glide pad will respond to a light touch from your fingertip.

### **Click, Double-click, and Right-click**

To click or double-click, you can use the left button just like that of a mouse. Instead of clicking the left button, you can also just tap gently anywhere on the rectangular pad. For right-clicking, you must use the right button.

### **Drag and Drop**

You can move icons or windows by using “drag and drop” below:

1. Position the pointer over the object.
  2. Press the left button; do not release it.
  3. Holding down the button, move the pointer. The object moves together with the pointer.
  4. Release the button when the object reaches its destination.
- Or you can tap the pad twice instead of pressing the left button in step 2.

### **Scroll**

You can scroll through information in a list or in a document by using the glide pad. To view information vertically, place your finger on the most right part of the glide pad and slide your finger up and down. To view horizontally, place your finger on the bottom part of the glide pad and slide your finger left or right. This procedure works only in limited applications.

---

## **Changing the Configuration**

In the *Mouse Properties* dialog box, you can change the configuration of the glide pad, such as swapping left and right buttons, changing the pointer size, etc. Double-click  icon on the taskbar.



---

# Using the Keyboard

---

Your computer, equipped with the Windows Enhanced Keyboard, provides all the functionality of a full-sized desktop keyboard. The keyboard will raise automatically when you open the display cover.



- *The keyboard of your computer will raise automatically when you open the display cover. You need to tilt the cover more than 90-degrees to raise the keyboard completely. Otherwise the keyboard or the computer may malfunction.*

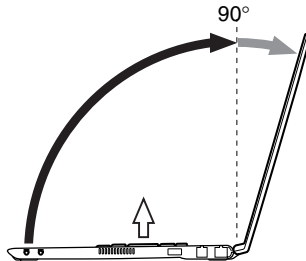

## Special Keys



Windows Key

Opens the Windows Start menu.



Application Key

Opens an application-specific short-cut menu equivalent to right-clicking.

## System Function Keys

When pressed together with the **Fn** key, function keys set specific system parameters. This combination is sometimes referred to as “hot keys”.

**Fn + F3**      Decreases the audio volume

**Fn + F4**      Increases the audio volume

**Fn + F5**      Rotates display mode in LCD only, CRT only, and simultaneously display.

Fn + F6	Decreases the LCD screen brightness.
Fn + F7	Increases the LCD screen brightness.
Fn + F11	Turns on and off the LCD screen.
Fn + F12	Forces the computer into System standby. See <i>Power Management</i> of Chapter 3 for more information.

---

# Sharing the Computer (Windows 2000)

---

For the details, refer to Windows 2000 Professional Quick Start Guide.

---

## Registering New Users to Your Computer

1. Log on to your computer with the name of the administrator.
2. From the *Start* menu, select *Settings – Control Panel*.
3. Double-click *Users and Passwords* icon.
4. In *Users and Passwords* dialog box, check *Users must enter a user name and password to use this computer*; then, click *Add.....*
5. Type a new user's name and click *Next*.
6. Type a new user's password twice; then, click *Next*.
7. Select the user's access level and click *Finish*.
8. Click *OK* to close the dialog box.
9. Close *Control Panel* window.

---

## Changing User Name

1. Follow the steps 1 to 3 of the above.
2. In *Users and Passwords* dialog box, check *Users must enter a user name and password to use this computer*; then, double-click the user name you want to change.
3. Change the name and click *OK* twice.
4. Click *Yes*.
5. Type the user name and its password; then, click *OK* to log on to the system.
6. Close *Control Panel* window.

---

## Changing User Password

If you want to change the password of the currently logged-on user;

1. Press **Ctrl+Alt+Delete** simultaneously.
2. In *Windows Security* window, click *Change Password....*
3. Type the old and a new passwords; then, the new password again for confirmation.

4. Click *OK* twice.
5. Click *Cancel* to back to Windows 2000.

If you want to change the password of another user (For administrator only);

1. Follow the steps 1 to 3 on *Registering New Users to Your Computer*.
2. In *Users and Passwords* dialog box, check *Users must enter a user name and password to use this computer*; then, click the user name you want to change its password.
3. Click *Set Password.....*
4. Type a new password twice for confirmation.
5. Click *OK* twice.

---

## Sharing the Computer (Windows XP Professional)

---

If you are sharing the computer with your colleagues or family members, set a user account for each person. Every user can choose their favorite desktop setting, web site lists, or make their own *My Documents* folder etc., and save them to their user accounts. When you turn on the computer, select your user account.

---

### Set a New User Account

1. Click *start - Control Panel*.
2. Click *User Accounts*. If Classic view is selected, double-click *User Accounts* icon.
3. Click *Create a new account*.
4. Type a name for the new account and click *Next*.
5. Select the account type; then, click *Create Account*. If you have selected a *Limited account*, then that user account has limits for using the computer. See *Help and Support Center* for more details.
6. Close *User Accounts* dialog box; then, *Control Panel*.

If you add a new user account(s), you must select which user account you will log in when you turn on the computer.

---

## Log off the Computer

“Log off” is useful because you do not have to turn off the computer when you finish your task and pass the computer to another person. There are two ways to log off the computer, *Switch User* or *Log Off*.

If you select *Switch User*, you can pass the computer to another person without closing your current applications. For example, if you are viewing a Web site, and your colleague needs to open a program on the computer, use *Switch User*. You can then view the same Web site by just switching users after your colleague finishes with the computer.

If you select *Log Off*, the system will close all your session and you need to save your files before logging off the computer.

1. Click *start - Log Off*.
2. Select *Switch User* or *Log Off*. If you select *Log Off*, the dialog box, which asks you to save your data may appear.
3. Select a new account to start Windows XP again.



*If you cannot see Switch User in Log Off Windows dialog box, click Change the way users log on or off in User Accounts dialog box, and check Use Fast User Switching and click Apply Options.*

---

## Set Password to User Account

You can set the password to a user account to avoid unauthorized use of your computer. Once you set the password, you need to enter it when you log on to your account. If you lose the password, you cannot start the computer with that user account, so unnecessary password setting can cause trouble in starting the system.

### Setting Password

1. Click *start - Control Panel*.
2. Click *User Accounts*. If Classic view is selected, double-click *User Accounts* icon.
3. Select the account you want to set a password to. You will only have this option if you log onto the computer with an Administrator account. If you log

on the computer with a limited user account, go to the next step. (You cannot set the password for another user account.)

4. Select *Create a password*.



- *If the password has been already set, Create a password will not appear.*
- *Only an administrator can set the password of another user account.*

5. Type a new password.
6. Type the new password again to confirm it.
7. If necessary, type a password hint word to remember the password you set.
8. Click *Create Password*.
9. Close *User Accounts* dialog box; then, *Control Panel* window.

### **Changing Password**

1. Follow the steps 1-2 on the above section.
2. Select the account you want to change, if you log on to the computer with an Administrator account. If you log on the computer with a limited account, go to the next step. (You cannot change the password for another user account.)
3. Select *Change the password or my password*.



- *If the password has not been set yet, Change the password or my password will not appear.*
- *Only the administrator can change the password of another user account.*

4. Type a new password.
5. Type the new password again to confirm it.
6. If necessary, type a password hint word to remember the password you set.
7. Click *Change Password*.
8. Close *User Accounts* dialog box; then, *Control Panel* window.

### **Deleting Password**

1. Follow the steps 1-2 on *Setting Password*.
2. Select the account you want to delete its password, if you log on to the computer with an Administrator account. If you log on the computer with a

limited account, go to the next step. (You cannot delete the password for another user account.)

3. Select *Remove the password or my password*.



- *If the password has not been set yet, Remove the password or my password will not appear.*
- *Only the administrator can delete the password of other user accounts.*

4. If you log on to the computer with the name of administrator and want to delete the password of that administrator, type the password and click *Remove Password*.
5. Close *User Accounts* dialog box; then, *Control Panel* window.

## Battery and Power Management

This chapter explains how to manage the computer's power effectively and use the battery pack.



*In this section, you often see the expression “Power Options Properties dialog box”. To open the dialog box:*

1. *From the Start menu, select Settings – Control Panel.*
  2. *Double-click Power Options icon. (Windows 2000)*
- or*
1. *Click start - Control Panel.*
  2. *Click Performance and Maintenance - Power Options in Category view or double-click Power Options icon in Classic view. (Windows XP Professional)*

---

### Battery Pack

---

When not connected to an external power source, your computer operates with the rechargeable battery pack. The duration of the battery life may be longer if the computer's Power Management is active. See the next section for power management.

To keep the battery life long:

- Condition (see “*Conditioning the Battery Pack*” later in the chapter) the battery pack if the actual remaining power in your battery is less than what Windows Power Meter indicates.
- Turn off your computer when you are not using it.



- *The duration of the battery will depend on the computer usage. Using applications, which heavily use the optical drive or external peripherals will experience shorter battery life*



*peripherals, will experience shorter battery life.*

- *When using the computer for several hours with battery packs, enable power management and set System hibernate. Refer to the Power Management section in this chapter.*
- *When the battery has not been charged, your computer may not operate properly. Connect the AC power to charge the battery.*

---

## Charging the Battery Pack

1. Connect the AC adapter to the computer. While the battery is being charged, the battery indicator turns orange.
2. When the battery is fully charged, the battery status indicator turns green. Charging time may vary according to the status of the computer.



- *Battery status indicator may turn off even while the battery pack is being charged. This is because the battery pack is hot, and the charging stops temporarily. When the battery becomes cool, the charging will start and the battery status indicator will turn on again.*
- *The battery pack may not be installed correctly if the battery status indicator blinks orange. In this case, turn off the computer, remove the AC adapter and the battery pack; then, install the battery pack and connect the AC adapter again. If the battery status indicator still blinks orange, ask your local dealer for assistance.*
- *When the battery pack is hot (for example, after a long usage), it may take longer to fully charge the battery pack.*

---

## Checking the Battery Level

You can check the battery level by pointing to the battery or AC plug icon on the taskbar, or double-clicking the icon to open the *Power Meter* dialog box. If the battery is fully charged, remaining capacity level will not appear even if you point the icon.

If you cannot see the battery or AC plug icon, follow the instructions below:

1. In the *Power Options Properties* dialog box, select *Advanced* tab.
2. Check *Always show icon on the taskbar* and click *OK*.
3. Close *Control Panel* window.



- *The remaining operating time depends on the power you are consuming. If you are using the audio system, PC card slot, hard disk drive, floppy disk or optical disk, your computer may consume more*

*battery life.*

- *If the actual remaining power in your battery is less than what Windows Power Meter indicates, you should condition the battery pack as per the procedure on “Conditioning the Battery Pack”.*

---

## Low Battery Indication

When the battery power becomes significantly low, the battery indicator (🔋) turns red, the warning beep sounds for about ten seconds. Save your data and turn off the computer, or connect the computer to AC power immediately. Otherwise, the computer will be shut down and the data may be lost.

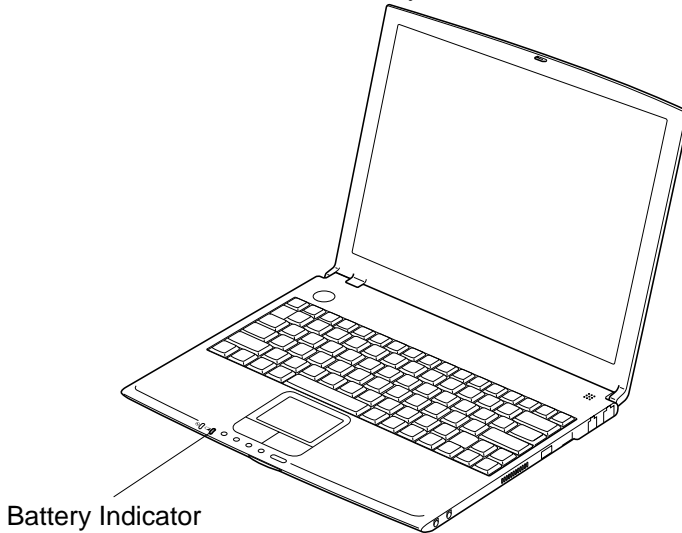

In Windows, the alarm will tell you when the battery drops to the specified level by sounding an alarm or displaying a message, and let your computer go on *System standby/hibernate* or be shut down automatically.

1. In the *Power Options* dialog box, select *Alarms* tab.
2. Set the battery level at which the alarms are activated. We recommend you set *Critical battery alarm* to more than 5 %.
3. Set the *Alarm Action* desired.
4. Click *OK* twice.
5. Close the *Control Panel* window.

---

## Conditioning the Battery Pack

You need to condition the battery pack when the actual remaining power in your battery is less than what Windows Power Meter indicates, or you buy a new battery pack.

1. Make sure the computer is turned off. Connect the computer to AC power and wait until the battery is fully charged. The battery indicator turns orange first; then, turns to green when the battery pack is fully charged.
2. Turn on the computer.
3. When the message *Press <F2> to enter SETUP* appears, press **F2** to open the Setup Utility.
4. Disconnect the AC adapter, and leave the computer on until the battery is completely discharged and the system shuts down automatically.
5. Connect the computer to AC power and let the battery fully charge again.
6. Turn on the computer and follow the steps 3 to 5 again.
7. Restart the computer. The conditioning process is complete.



---

*Do not connect the computer to wall outlet while discharging the battery. The conditioning will be cancelled.*

---

---

## Changing the Battery Pack

The capacity of a battery pack gradually decreases when used repeatedly (the deterioration rate depends on the operating environment). If the battery life becomes extremely short even after the conditioning, you should buy a new standard battery pack (CE-BL17). An optional battery pack (CE-BL18) is also available in some countries.

When you replace the battery pack with a new one:

1. Turn off the computer and disconnect the AC adapter from the computer.
2. Close the display cover and turn over the computer on a flat place.

3. Slide the battery stopper to the unlocked position (Ⓐ).

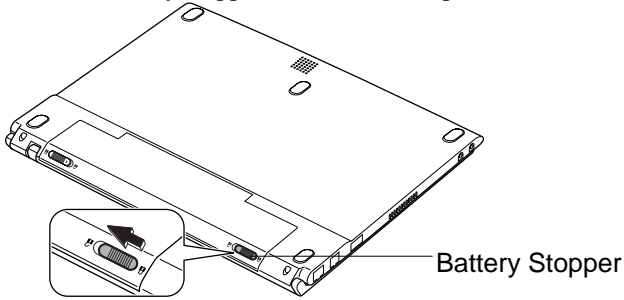

4. Slide the battery release lever to the right and hold it; then, pull out the battery pack.

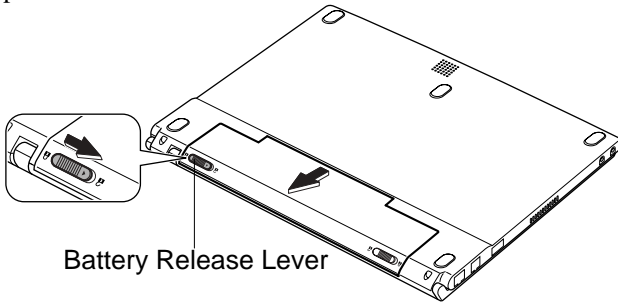

5. Lift up the battery pack and remove it from the computer.

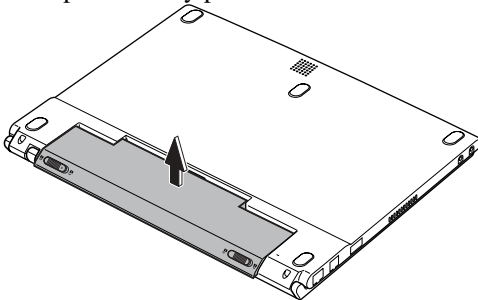

6. Slide the battery stopper of a new battery pack to the unlocked position (Ⓐ).

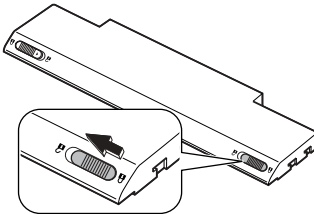

7. Insert the battery pack into the computer by matching the notched part of the battery to the projected parts on the computer.

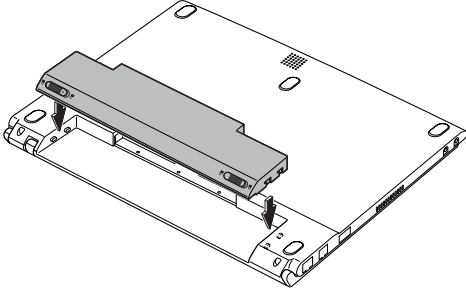

8. Push the battery pack until you hear the clicking sound.

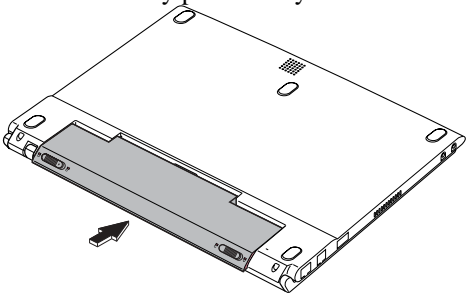

9. Slide the battery stopper to the locked position (A).

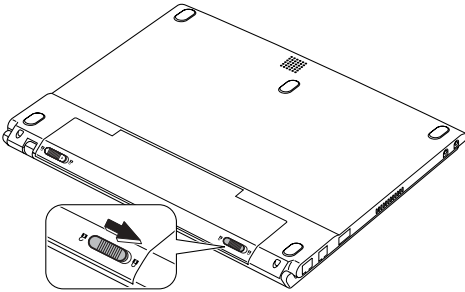

10. Turn over the computer and it's ready to use.

---

## Optional High Capacity Battery Pack

---

To power your computer for extended periods of time, there is an optional battery pack, the high capacity battery pack (CE-BL18)(may not be available in some countries).

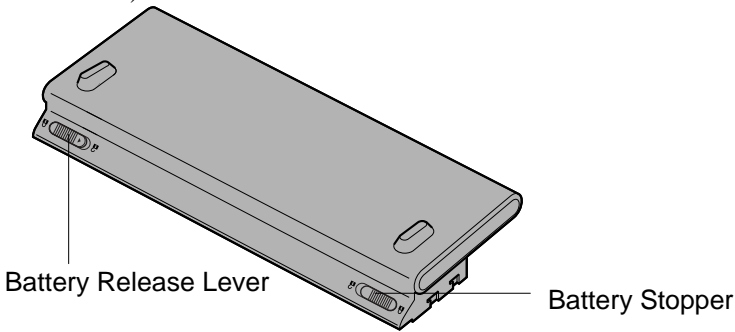

*Use only the appropriate optional battery (CE-BL18), and attach it correctly.*

---

---

### Connecting High Capacity Battery Pack

Follow the steps in *Changing the battery pack* of this chapter.

---

### Charging High Capacity Battery Pack

Follow the steps in *Charging the battery pack* of this chapter.

---

### Checking the Battery Level of High Capacity Battery Pack

Follow the steps in *Checking the Battery Level* of this chapter.

---

### Conditioning the High Capacity Battery Pack

Follow the steps in *Conditioning the battery pack* of this chapter.

---

# Power Management

---

Power management saves electricity and extends battery life by controlling power supply to built-in devices. You can set the following power management properties in Windows.

- Stopping power supply to the hard disk
- Stopping power supply to the display
- Controlling CPU speed
- Using System standby/hibernate

To open *Power Options Properties* dialog box, from the *Start* menu, select *Settings – Control Panel*, and double-click *Power Options* icon. (Windows 2000) Or click *start – Control Panel*, and click *Performance and Maintenance*; then, *Power Options*. If Classic view is selected, double-click *Power Options* icon (Windows XP Professional).



*Note that the power management may not seem to function when you are using an application program that accesses the hard disk periodically.*

---

## Stopping Power Supply to the Hard Disk

1. In the *Power Options Properties* dialog box, select *Power Schemes* tab.
2. Set *Turn off hard disks* to an appropriate value, and click *OK*.
3. Close *Control Panel* window.

---

## Stopping Power Supply to the Display



*This procedure is also effective for an attached external monitor complying with power management.*

1. In the *Power Options Properties* dialog box, select *Power Schemes* tab.
2. Set *Turn off monitor* to an appropriate value, and click *OK*.
3. Close *Control Panel* window.



---

## Controlling CPU Speed (Windows 2000)

Your computer is equipped with Intel® SpeedStep™ technology which can control CPU speed to reduce power consumption.



*Do not control CPU speed while communicating, or reading/writing data. Otherwise the computer may malfunction.*

1. Double-click  or  icon on the taskbar.
2. In *Intel(R) SpeedStep(TM) technology* dialog box, select the CPU speed performance.
3. Click *OK*.



- *If Automatically change performance when the power source changes is checked in the dialog box, CPU speed will change automatically when the AC adapter is connected/disconnected except while using the built-in modem.*
- *You can also select the performance by right-clicking the icon, or selecting Intel(R) SpeedStep(TM) technology tab in Power Options Properties dialog box.*

---

## Controlling CPU Speed (Windows XP Professional)

Windows XP Professional will control the processor performance to reduce power consumption.



*Do not control the processor performance, or connect/disconnect the AC adapter while communicating, or reading/writing data. Otherwise the computer may malfunction.*

1. In the *Power Options Properties* dialog box, select *Power Schemes* tab.
2. Select an appropriate power scheme in *Power schemes* according to the table of the next page, and click *OK*.
3. Close *Power Options Properties* dialog box; then *Control Panel* window.



Power Scheme	Processor Performance	
Home/Office Desk	Using AC Power	Always runs at highest performance state
	Using Battery	Performance state will be chosen based on CPU demand
Portable/Laptop	Using AC Power	Performance state will be chosen based on CPU demand
	Using Battery	Performance state will be chosen based on CPU demand
Presentation	Using AC Power	Performance state will be chosen based on CPU demand
	Using Battery	Starts at lowest performance state; then, uses liner performance reduction as battery discharges
Always On	Using AC Power	Always runs at highest performance state
	Using Battery	Always runs at highest performance state
Minimal Power Management	Using AC Power	Performance state will be chosen based on CPU demand
	Using Battery	Performance state will be chosen based on CPU demand
Max Battery	Using AC Power	Performance state will be chosen based on CPU demand
	Using Battery	Starts at lowest performance state; then, uses liner performance reduction as battery discharges.



- *Note that Power scheme includes other power management settings (such as a timer for System standby, etc.) appearing on Power Schemes tab. Check those settings are set to an appropriate value when you select the processor performance using Power schemes facility.*
- *You can set your own Power scheme. Set all power management settings to your suitable ones, and click Save as...; then, type an*

*appropriate name and click OK.*

---

## Using System Standby/Hibernate

*System standby/hibernate* is a very useful power management tool. For example, after your computer has entered *System standby* mode, you can restart your computer more quickly when compared to a restart, after a normal shutdown operation. When your computer resumes from *System standby/hibernate*, the system restores the exact last state of the computer. In Windows, you can define *System standby* or *System hibernate* the system enters under what conditions.

- *System standby* stores the current condition of the computer in RAM and stops power supply to all but a few essential components. Your system enters and resumes from *System standby* per the conditions mentioned later. In *System standby*, the Power indicator or the battery power indicator blinks green. To resume from *System standby*, operate the computer again.
- *System hibernate* saves the current condition of the computer in an area of the hard disk and turns off the computer. Your system enters and resumes from *System hibernate* per the conditions mentioned later. In *System hibernate*, the power indicator or the battery power indicator turns off. To resume from *System hibernate*, press the power button.



*When entering/resuming from System standby/hibernate, follow the instructions below:*

- *Finish communications, printing, and playing music or video before entering System standby/hibernate.*
  - *Do not operate the computer or peripheral devices, or connect/disconnect peripheral devices, while entering/resuming from System standby/hibernate.*
  - *While operating with a battery, the computer may not resume from System standby/hibernate if the battery capacity is not enough. In this case, connect the AC adapter to your computer.*
  - *Save your data before your computer enters System standby. If the power supply to the computer is stopped, the RAM contents will be lost.*
  - *Select the user account if you see them when the computer resumes from System standby/hibernate.*
- 

## Supporting System Hibernate



*If your battery becomes completely discharged during System standby, you will lose unsaved data and will need to reboot your computer. Therefore, if you are planning to leave your computer powered by battery for long periods of time, we recommend System hibernate.*

Confirm that *System hibernate* is supported by the following steps below.

1. In the *Power Options Properties* dialog box, select *Hibernate* tab.
2. Confirm *Enable hibernation Support* (Windows 2000) or *Enable hibernation* (Windows XP Professional) is checked.
3. Click *OK*.
4. Close *Control Panel* window.

### Set Timer to Enter System Standby/Hibernate Automatically

Your computer will enter System standby/hibernate automatically when the specified time has passed without any operation. To set the time:

1. In the *Power Options Properties* dialog box, select *Power Schemes* tab.
2. Set the time after which the computer will enter System standby/hibernate in *System standby* or *System hibernates*.
3. Click *OK*.
4. Close *Control Panel* window.

### Entering System Standby/Hibernate

Your computer enters *System standby/hibernate* in each of the following cases:

- You select *Stand by or Hibernate* in the *Shut Down Windows* dialog box.(Windows 2000)
- You select *Stand By or Hibernate*(which will appear if you press **Shift** key) in the *Turn off computer* dialog box. To open the dialog box, click *start – Turn Off Computer*. (Windows XP Professional)
- The specified time in *System standby or System hibernates* in *Power Schemes* tab of *Power Options Properties* dialog box has passed without any operation (See the previous section).
- The screen cover is closed.

The above functions if you perform the following:

1. In the *Power Options Properties* dialog box, select *Advanced* tab.
  2. Select *Hibernate* or *Stand by* in *When I close the lid of my portable computer*:
  3. Click *OK*.
  4. Close *Control Panel* window.
- You press the power button.

The above functions if you perform the following:

1. In the *Power Options Properties* dialog box, select *Advanced* tab.
2. Select *Hibernate* or *Stand by* in *When I press the power button on my computer*:
3. Click *OK*.
4. Close *Control Panel* window.

- You press **Fn+F12**.

The above functions if you perform the following:

1. In the *Power Options Properties* dialog box, select *Advanced* tab.
2. Select *Hibernate* or *Stand by* in *When I press the sleep button on my computer*:
3. Click *OK*.
4. Close *Control Panel* window.



*If Ask me what to do is selected in the step 2 of You press the power button or You press **Fn+F12**, the Turn off computer dialog box will appear when you press the power button or **Fn+F12** key combination. You can select System standby or System hibernate at that timing.(Windows XP Professional only)*

- The battery level is low.

The above functions if you set the alarm in Windows. See *Low Battery Indication* in this section.

---

## Disabling Power Management

1. In the *Power Options Properties* dialog box, select *Power Schemes* tab.
2. Set *Turn off monitor*, *Turn off hard disks*, *System standby*, and *System hibernates* to *Never*; then, click *OK*.
3. Close *Control Panel* window.



## *Peripherals*

This chapter describes how to use peripheral devices with your computer. You can connect a floppy disk drive unit, a CD-ROM drive unit, a printer, external monitor, or other devices to your computer. To ensure proper use, be sure to read the instructions for each peripheral device before connecting it to your computer.

---

### Using Peripherals

---

You can use the peripheral devices shown on the next page. For the details, refer to the section explaining each device, and contact your dealer.



- *Be sure to turn off the computer and the peripheral device before connecting them (except when connecting USB devices or inserting a PC card).*
- *Confirm the peripheral device you will connect is Windows 2000 or Windows XP Professional compatible.*
- *Some devices have to be turned on after the computer is turned on.*
- *Some devices require that you install drivers before use (You may need to connect an optional external floppy disk drive unit or an optional external CD-ROM unit to install the drivers.)*

## Peripheral Connection Overview

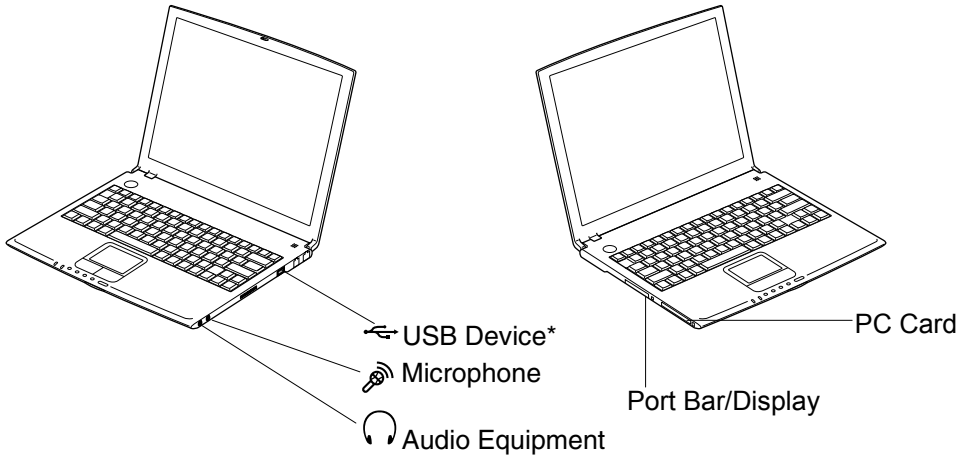

\*Including the optional external floppy disk drive unit (CE-FD04/05) and the optional external CD-ROM drive unit (CE-CD05).



---

# Using Optional External Floppy Disk Drive Unit

---

You can use double-density (2DD) 720KB or high-density (2HD) 1.44MB floppy disks with the optional external floppy disk drive unit (CE-FD04/05).

---

## Connecting Optional External Floppy Disk Drive Unit

---



- *Do not place the floppy disk drive unit on its side or upside down.*
  - *Do not press on the floppy disk drive unit. It may damage the drive or cause malfunction.*
  - *Do not place the AC adapter on the floppy disk drive unit. It may cause the drive to malfunction.*
- 

Connect the floppy disk drive unit cable to the USB port on the computer. Be sure to let the USB mark side up when connecting the cable to the computer. (CE-FD04 is required to connect the included USB cable to the drive first.)

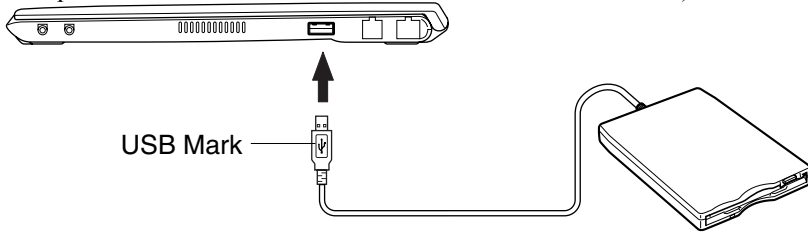

---

## Handling Floppy Disks

- Do not open the shutter and touch the disk inside; otherwise, you will not be able to read or write data to the disk.
- Do not place floppy disks near magnets or heat source, in direct sunlight or in a dusty place, etc.
- Never subject a disk to sudden shocks or extreme vibration. Do not drop, bend, or place heavy objects on a disk.
- Do not spill liquid onto a disk.

---

## Inserting and Removing a Floppy Disk

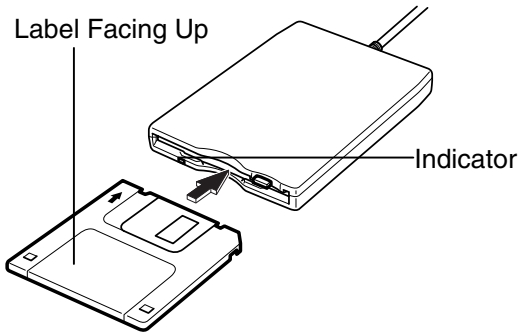

### Inserting

Hold the floppy disk with the arrow facing up and towards the drive. Slide the disk into the drive until it locks into place.



- *Always insert a floppy disk straight into the floppy disk drive.*
- *When inserting the disk, make sure it is not upside down.*
- *Do not use excessive force when inserting the floppy disk. If you have difficulty inserting or removing disks, seek the assistance of an authorized service technician.*
- *Do not touch the disk while reading/writing data. It may cause malfunction of the computer and the drive.*

---

### Removing



*Before removing the floppy disk, make sure the indicator of the floppy disk drive unit is not lit.*

Press the eject button firmly. The disk will pop out slightly. Remove it and store it properly.

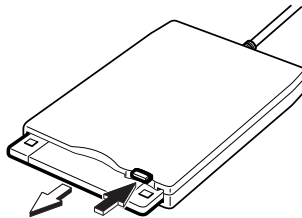

---

## Formatting a Floppy Disk

1. Make sure the floppy disk is not write-protected, and insert it into the floppy disk drive.
2. Double-click *My Computer* on the desktop (Windows 2000). Or click *start - My Computer* (Windows XP Professional).
3. Right-click *3 1/2 Floppy (A:)* icon; then, click *Format...* from the pull-down menu.
4. Select the appropriate formatting options.
5. Click *Start* to start formatting.



- *When you format a floppy disk, all data previously stored on the disk is lost.*
  - *You cannot format a double-density (2DD) 720KB floppy disk.*
- 

---

## Removing Optional External Floppy Disk Drive Unit

To remove the unit, you need to perform the following before you remove it:

### In Windows 2000

1. Click *Unplug or Eject Hardware* icon () on the taskbar.
2. Click *Stop Mitsumi USB Floppy – Drive(A:)*.
3. Click *OK* in *Safe To Remove Hardware*; then remove the unit.

### In Windows XP Professional

1. Click *Safely Remove Hardware* icon () on the taskbar.
2. Click *Safely remove Mitsumi USB Floppy – Drive(A:)*; then, *Safe To Remove Hardware* dialog appears.
3. Remove the unit from the computer.

---

# Using Optional External CD-ROM Drive Unit

---

Compact disc (CD) is a storage medium, with which you can read data, play music, install and run programs, etc. The optional external CD-ROM drive unit (CE-CD05) can be connected to the USB port on the right side of the computer.



---

## **CAUTION FOR LASER**

*Use of controls or adjustments or performance of procedures other than those specified herein may result in hazardous radiation exposure. Maximum output and wavelength of the laser: 903 $\mu$ W, 785nm*

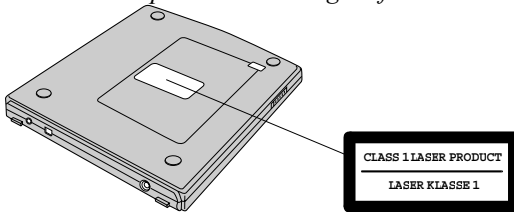

---

## **Precautions**

- Do not disassemble the CD-ROM drive unit and do not repair by yourself, otherwise it may cause electrical shock hazard, or a laser may damage your eyes.
- Do not store or use the CD-ROM drive unit in a dusty, humid, oily environment, or under damp or moist conditions.
- Do not turn up the volume too high, when using the headphones.
- Do not leave the CD-ROM drive unit in direct sunlight, near a heat source or especially in a hot automobile.
- Do not drop or jar the CD-ROM drive unit.
- Do not touch the pins/terminals of the USB cable.
- When the CD-ROM drive unit has been moved from a cold place to warm place, it may damp or moist. Leave it for about 1 hour before using.
- Keep magnetic objects away from the CD-ROM drive unit.
- Do not insert any foreign metal object inside the CD-ROM drive unit.
- Do not touch the lens.

- If noise is heard from radio or TV, move the CD-ROM drive unit 2 m (about 6 ft.) away from the radio or TV.

---

## Connecting Optional External CD-ROM Drive Unit (CE-CD05)

---



- *Do not place the CD-ROM drive unit on its side or upside down.*
  - *Do not press on the CD-ROM drive unit. It may damage the drive or cause malfunction.*
  - *Do not place the AC adapter on the CD-ROM drive unit. It may cause the drive to malfunction.*
- 

1. Connect the core side connector of the included USB cable to the cable connector of the drive unit.

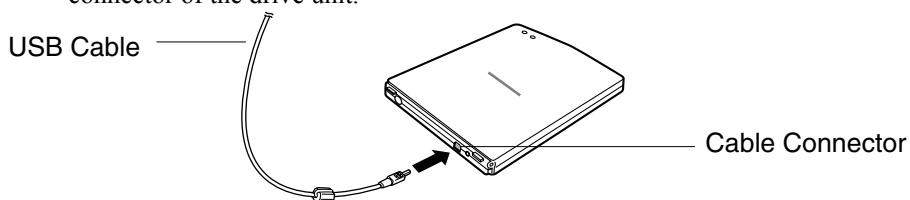

2. Connect the USB connector of the cable into the USB port of the computer.

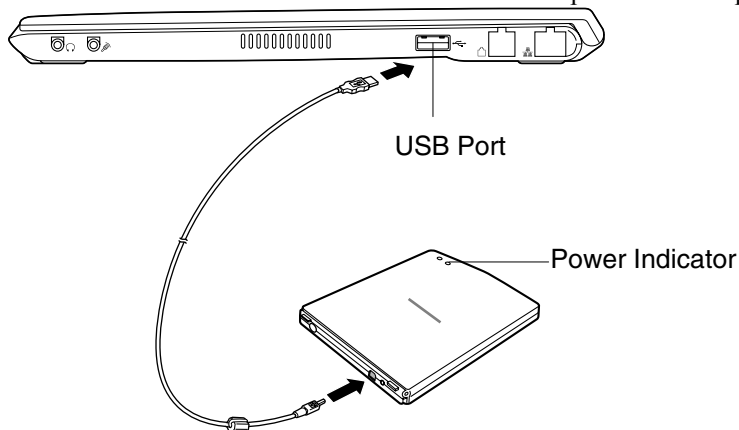

The CD-ROM drive unit turns on automatically and the power indicator is lit.

- Slide the cover latch to the right and open the cover.

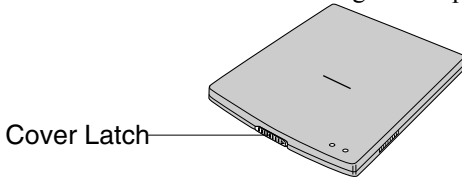

- Remove the protection sheet before you use the drive for the first time.

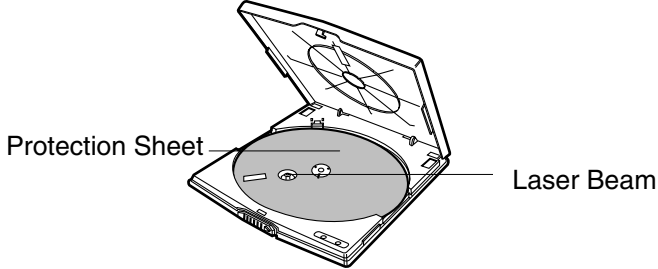

---

## Handling CDs

- Do not write on either side of the disk, particularly the non-label side. Data is read from the non-label side. Do not mark this surface.
- Keep your disks away from direct sunlight, heat and excessive moisture.
- Always hold the CDs by the edges. Fingerprints, dirt or water on the CDs can cause noise or mistracking. If a CD is dirty or does not play properly, clean it with a soft, dry cloth, wiping straight out from the center, along the radius.

---

## Inserting a CD

You can operate the optional external CD-ROM drive unit only when the computer is on.

- Make sure the busy indicator does not light on.

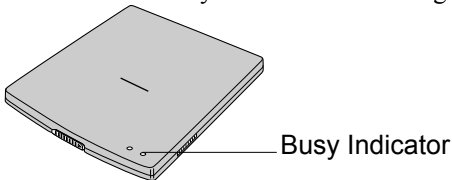

- Slide the cover latch to the right to open the cover and raise it.

3. Place your CD onto the disk spindle and press on the center of your CD with label side up, until it locks onto the disk spindle.

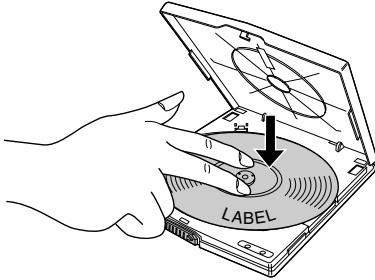

4. Close the disk cover.



- Insert a CD firmly until it locks onto the spindle; then, close the disk cover, or the disk may fall off the spindle and get damaged.
- Do not leave the tray open. Also, avoid touching the lens in the tray. If the lens becomes dirty, the CD-ROM may malfunction.
- Do not wipe the lens with materials with rough surface (such as paper towels). Instead, use a cotton swab to gently wipe the lens.

---

## Removing a CD

1. Make sure the busy indicator is not lit.
2. Slide the cover latch to open the cover and raise it.
3. Press on the disk spindle and remove the CD from the tray by holding its edge.

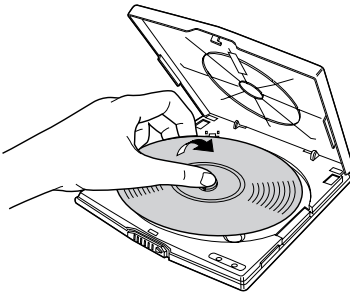

- Make sure the Busy indicator is not lit or blinking before opening the disk cover.
  - When opening the cover, if the CD is still spinning, wait until it has stopped, then remove it.
-

---

## Playing a CD

With some CD-ROMs, you can hear the sound of them through the audio out jack of the CD-ROM drive unit.

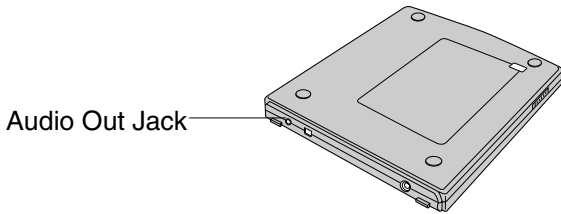

Connect headphones or speaker system with an amplifier to the audio out jack.

---

## Removing Optional External CD-ROM Drive Unit

### In Windows 2000

1. Remove the CD from the CD-ROM drive unit.
2. Click *Unplug or Eject Hardware* icon (  ) on the taskbar.
3. Click *Stop USB Mass Storage Device*.
4. Click *OK*; then, remove the USB cable from the computer.

### In Windows XP Professional

1. Click *Safely Remove Hardware* icon (  ) on the taskbar.
2. Click *Safely remove USB Mass Storage Device*; then, *Safe To Remove Hardware* dialog appears.
3. Remove the USB cable from the computer.

---

## Mode Switches

There are the mode switches on the bottom of the CD-ROM unit.

These switches are for technical services. Keep them as a default setting; *OFF*.

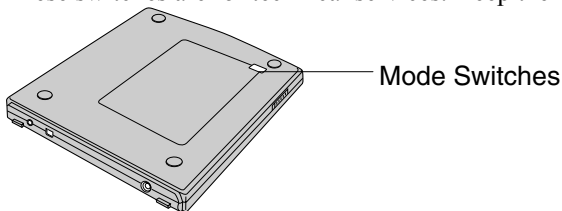



---

## **Cleaning Optional External CD-ROM Drive Unit**

- Do not use solvents such as benzine, thinner, alcohol, record cleaner or anti-static spray.
- Clean the outside of the drive with a soft, dried cloth.
- Clean the lens with a commercial lens blower if the lens is dirty.

---

# Display

---

You can use an external monitor with your computer. To display images on both displays simultaneously, use the 1024x768 resolution.



- *Some monitors, which are not compatible with your computer, may not display correctly.*
- *In this section, you often see the expression “Display Properties dialog box.” To open the dialog box, right-click somewhere on the Windows desktop and select Properties from the pull-down menu.*

---

## Connecting External Monitor

---

Use the included external monitor cable adapter (QCNWA1587ACZZ) to connect an external monitor to your computer.

1. Turn off the computer and the external monitor.
2. Connect the included external monitor cable adapter to the expansion port of the left side of the computer.

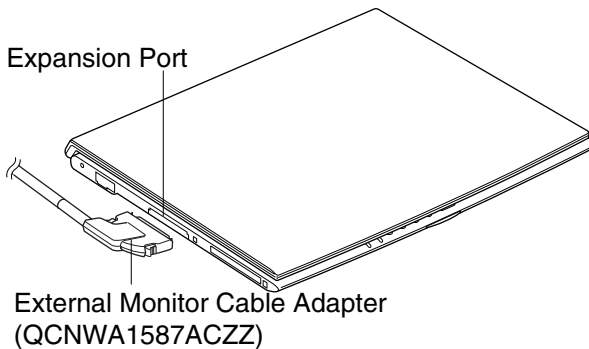

3. Connect the other end of the external monitor cable adapter to one end of your external monitor cable.
4. Connect the other end of your external monitor cable to your external monitor.
5. Turn on the external monitor; then, turn on the computer.

---

## Disconnecting External Monitor

1. Turn off the computer and the external monitor.
2. Press the buttons on the both sides of the connector of the external monitor cable adapter and remove the connector from the expansion port.

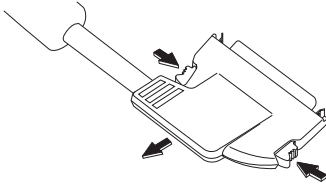

3. Remove the external monitor adapter from the display cable.

---

## Displaying the Screen on an External Monitor

To display the screen on an external monitor, you may need to install the driver for your external monitor. Before using the external monitor, refer to the manual included with your external monitor.

---

## Switching the Display

1. In the *Display Properties* dialog box, select *Settings* tab; then, *Advanced*.
2. Select *Displays* tab.
3. Select the display and click *OK*.
4. Click *Yes*; then, *OK*.



- You can also switch the display with **Fn+F5**.
- While playing video or animation, you may not be able to switch the display.

---

## Changing Resolution and Number of Colors

When shipped, your computer is set to the default resolution and color. The default resolution is 1024 x 768 at 64k color. To change the resolution and the number of colors, perform the following:

1. In the *Display Properties* dialog box, select *Settings* tab.
2. Select the number of the colors in the *Colors* or *Color quality*, and select the resolution in *Screen area* or *Screen resolution*. Refer to the table of the next page.
3. Click *OK* twice; then, *Yes*. (Windows 2000)  
Click *OK*; then, *Yes*. (Windows XP Professional)

### Resolutions and Colors you can choose

Resolution	Number of Colors
640 x 480 (Windows 2000 only)	256 64K 16M <sup>(*)</sup>
800 x 600	256 64K 16M <sup>(*)</sup>
1024 x 768	256 64K 16M <sup>(*)</sup>
1280 x 1024 <sup>(**)</sup>	256 64K 16M <sup>(*)</sup>
1600 x 1200 <sup>(**)</sup>	256 64K

(\*1) On the internal LCD screen, the number of colors in this mode is made using a Dithering algorithm.

(\*2) Only 1024 x 768 dots appear even on the internal LCD screen of 1280 x 1024 or 1600 x 1200 resolution. To see the hidden parts, move mouse pointer to the parts and scroll it. If you use Windows 2000, *Hide modes that this monitor cannot display* of *Monitor* tab must be unchecked in order to set 1280 x 1024 and 1600 x 1200 resolution mode selectable. *Monitor* tab will appear when you click *Advanced* tab in the *Display Properties* dialog box.



- *You cannot switch to a display resolution and number of colors that are not available.*
- *In the Colors, High Color (16 bit) means 65,536 (64K) colors, and True Color (24 bit or 32 bit) means about 16,770,000 (16M) colors.(Windows 2000)*
- *In the Color quality, Medium (16 bit) means 65,536 (64K) colors, and High(24 bit) or Highest(32 bit) means about 16,770,000 (16M) colors.(Windows XP Professional)*
- *If you select True Color, High or Highest;*
  - *Drawing speed may be delayed.*
  - *When playing animation, the screen may be distorted.*

---

# Audio System

---

You can output sound to speakers or headphones.

---

## Connecting Audio Equipment

You can connect stereo speakers with an amplifier or an audio equipment to the audio output jack on the right side of the computer.

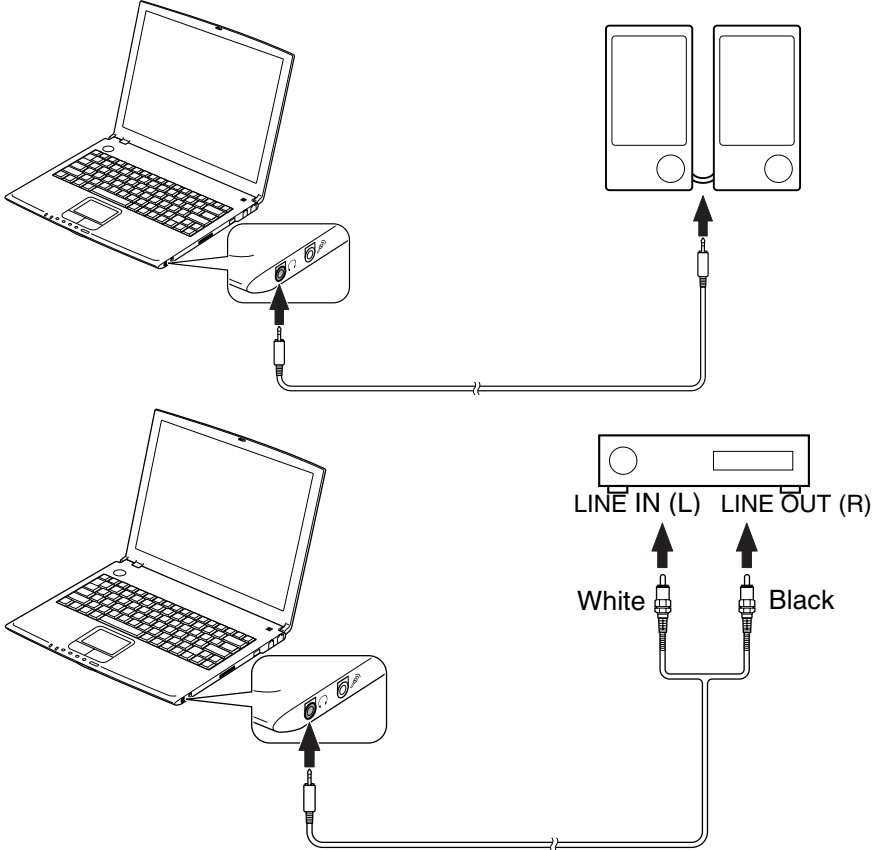

*You can adjust the output volume in Windows by double-clicking the speaker icon in the taskbar or use **Fn + F3** or **F4** keys combination.*

---

## Connecting a Headphone

Use the headphone with an impedance of more than  $8\Omega$  ( $32\Omega$  is recommended).

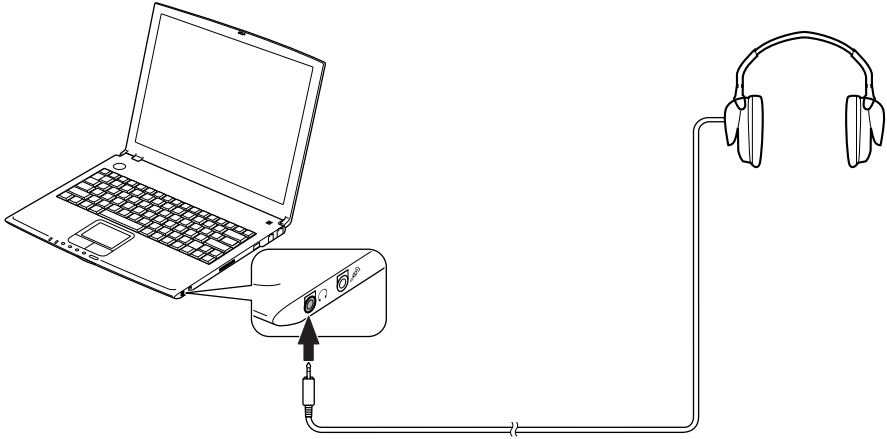

4

---

## Connecting Microphone

You can input sound using an external microphone connected to the microphone jack. Use an electret condenser microphone with an impedance of  $2.2k\Omega$  and an allowable voltage of  $2V$ .

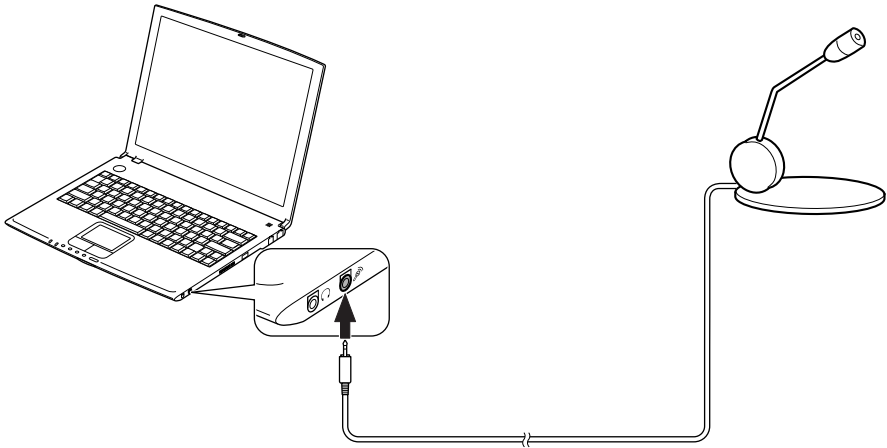

---

# USB Device

---

Your computer has an interface called Universal Serial Bus (USB). With a USB connection, you can connect/disconnect peripherals without turning off the computer. Generally, when you connect a device to the computer, the necessary driver will be installed automatically. See also the manuals of peripheral devices supporting USB.





*When a new device is correctly connected to the computer, the appropriate driver is automatically installed. If the driver is not installed correctly, you will hear a warning beep. In this case, install the driver by following the instructions on the screen.*

To remove USB devices, you may need to perform the following before you remove them:

## In Windows 2000

1. Click *Unplug or Eject Hardware* icon () on the taskbar.
2. Click *Stop xxxxx* (xxxxx is the name of your USB device).
3. Click *OK*; then, remove the device from the computer.

## In Windows XP Professional

1. Click *Safely Remove Hardware* icon () on the taskbar. If you cannot find the icon, click  to show all kinds of icons.
2. Click *Safely remove xxxx* (xxxxx is the name of your USB device); then, *Safe To Remove Hardware* dialog appears.
3. Remove the device from the computer.

---

# PC Card

---

Your computer is equipped with a PC card (PCMCIA) slot, which can accommodate one Type II card or CardBus compliant card. You can insert/eject a PC card without turning off the computer. Before inserting a PC card into your computer, refer to its manual.

---

## Inserting PC Card



*When a new card is correctly inserted, the appropriate driver is automatically installed. If the driver is not installed correctly, you will hear a warning beep. In this case, install the PC card driver by following the instructions on the screen.*

1. Confirm the PC card eject button is inside the computer cabinet.

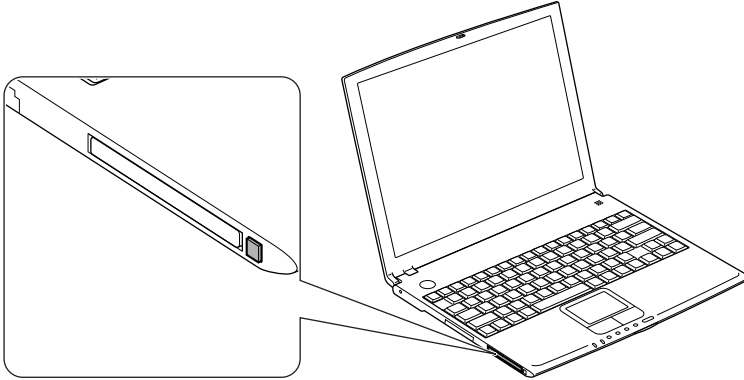

2. Push the PC card eject button so that it pops out from the side of the computer.

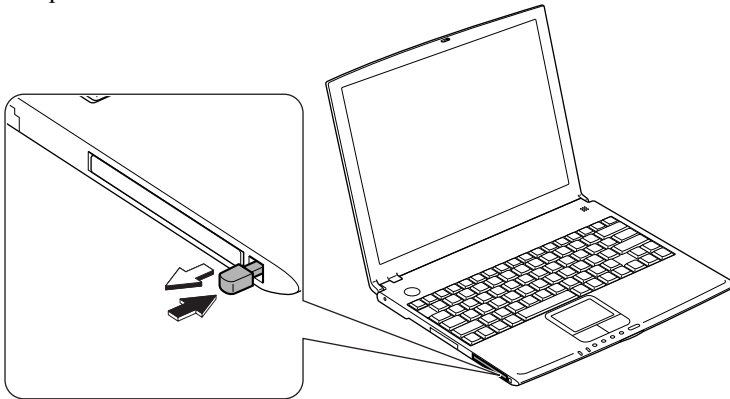



3. Push the PC card eject button again and remove the protection card.

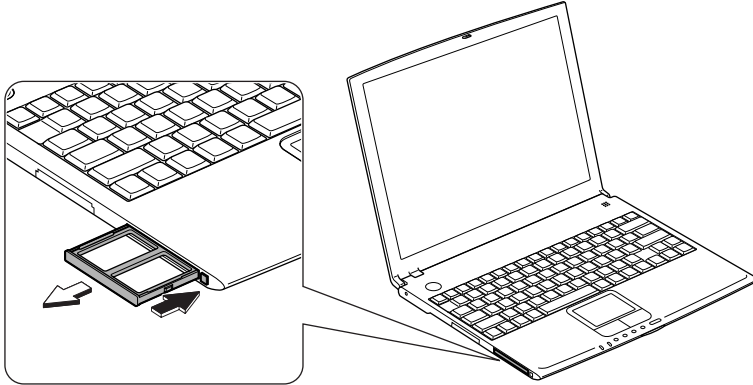

4. Push the PC card eject button all the way inside the cabinet for safekeeping.
5. Insert a PC card into the slot with the label face up until it locks into place.

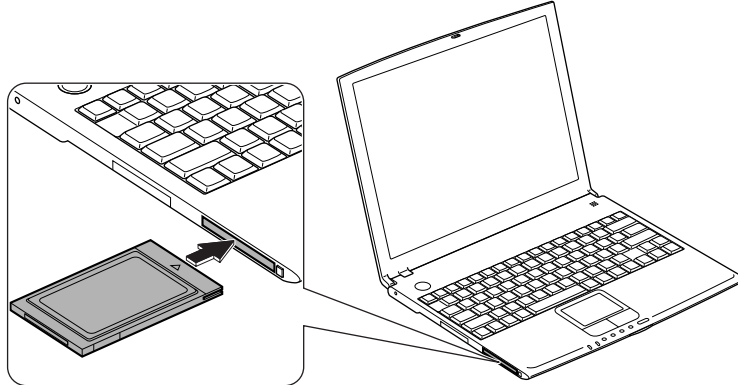

---

## Ejecting PC Card





- *Some PC cards may become hot after long use.*
- *Be sure to use the procedure below when ejecting a PC card. Otherwise, the system may not work properly.*

---

### In Windows 2000

1. Click *Unplug or Eject Hardware* icon () on the taskbar.
2. Click *Stop xxxxx* (xxxxx is the name of your PC card).
3. Click *OK* and go to *Ejecting PC card* of the next page.

## In Windows XP Professional

1. Click *Safely Remove Hardware* icon (  ) on the taskbar. If you cannot find the icon, click  to show all kinds of icons.
2. Click *Safely remove xxxx* (xxxxxx is the name of your USB device); then, *Safe To Remove Hardware* dialog appears. Go to *Ejecting PC card* below.

## Ejecting PC Card

1. Push the PC card eject button so that it pops out from the side of the computer.

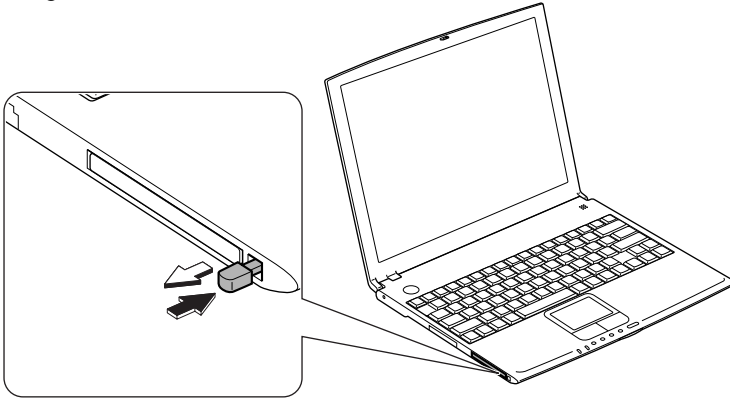

2. Push the eject button and remove the PC card.

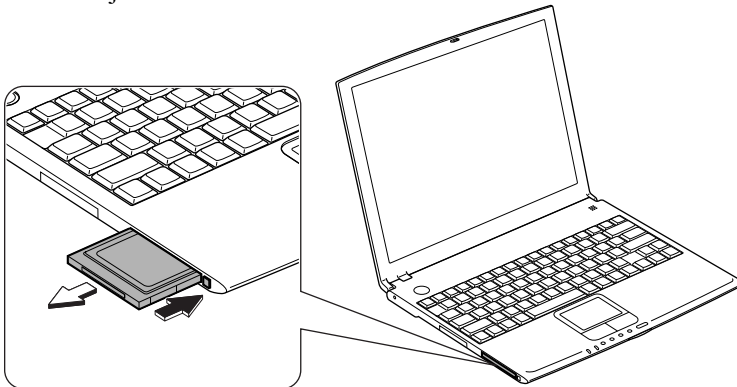

3. Push the PC card eject button all the way inside the cabinet for safekeeping.
4. Insert the protection card.



*Be sure to insert the protection card after you finish using the PC card to protect the PC card slot from being damaged.*

---

# Printer

---

You can connect a printer to the USB port.



*Before using a printer, read the printer manual and install the printer driver.*

---

## Using the Optional Port Bar

---

The optional port bar (CE-PB01) is a convenient station adding extra ports to your computer. You can leave peripheral devices such as a printer or an external display permanently connected to the port bar, and take your computer out of your office or house. When you connect the port bar to your computer again, all the devices connected are instantly available.

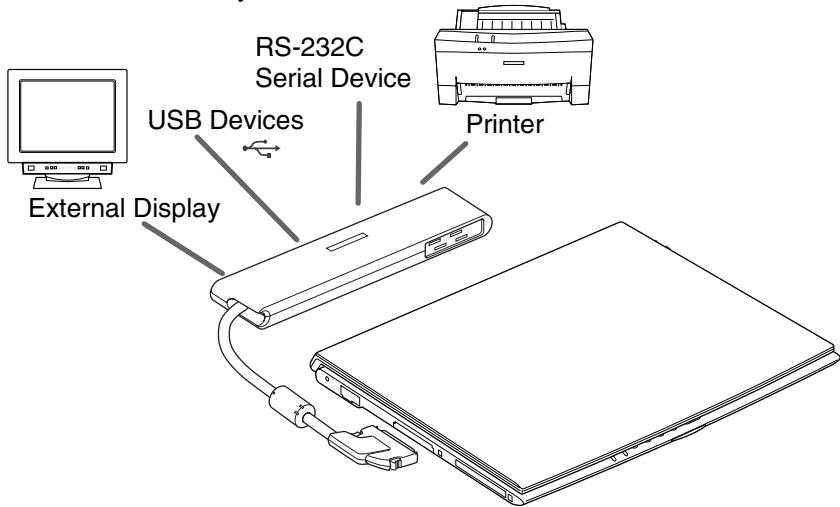

---

## Connecting the Port Bar

---



*Be sure to turn off the computer before connecting/disconnecting the port bar. Otherwise the computer may malfunction.*

1. Turn off the computer.
2. Remove the cover of the expansion port.

3. Connect the cable of the port bar to the expansion port of the computer.

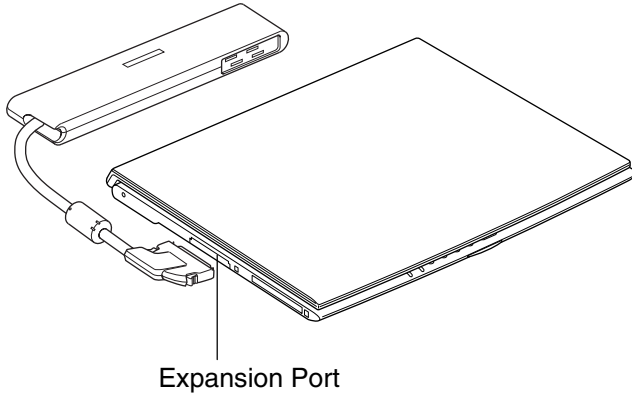

4. Turn on the computer.

## 4 Using the Port Bar

All the ports available are located on the back of the port bar.

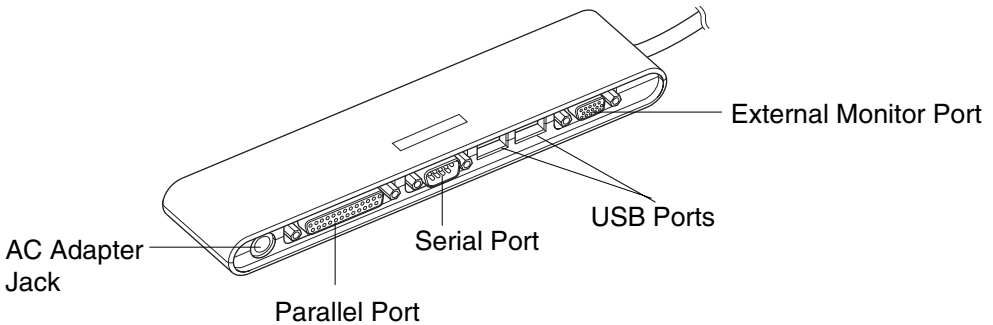

You can connect/disconnect the devices to/from the external monitor port, the USB ports, and the parallel port while the computer is on.

When you use the serial port, be sure to connect the device to the port bar before you turn on the computer.

## Disconnecting the Port Bar

1. Turn off the computer and the devices connected to the port bar.

2. Press the buttons on the both sides of the connector and remove the connector from the expansion port.

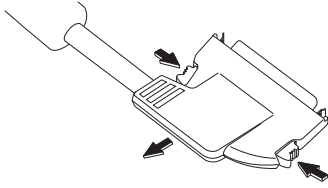

3. Store the connector into the port bar.



## Communication Functions

This chapter explains how to use the built-in modem and the LAN unit.

---

### Built-in Modem (may not be available in some countries)

---

You can use the built-in modem for data transfer and fax communication.



- *The built-in modem on your computer is designed only for regular analog telephone lines. The modem may be damaged when connected to a digital ISDN terminal or a digital PBX.*
  - *Use TA (terminal adapter) to connect the built-in modem to a digital telephone line.*
  - *If an unusual device is attached to the line you are connecting to, the modem may not function properly. Remove the device or contact the dealer of the device.*
  - *Before connecting to a PBX, consult the PBX maintenance staff or its service company. If the electric characteristics of your PBX are different from those of a regular analog line, the modem will not function properly. If you connect the modem to a digital PBX, both the modem and the PBX may be damaged.*
- 

### Connecting the Modem to a Telephone Line

1. Turn off your computer.

2. Remove the cover of the modem jack on the right side of your computer.

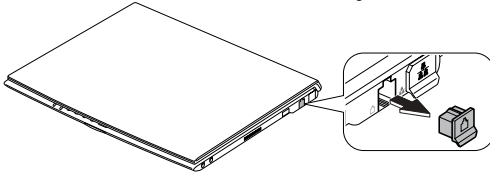

*To avoid damaging the modem, keep the modem cover, and attach it after you finish using the built-in modem.*

3. Connect one end of the included modem cable to the modem jack.



---

*Do not connect the modem cable to the LAN jack next to the modem jack. It may damage the LAN jack or the modem cable.*

---

4. Connect the other end of the modem cable to the telephone line.

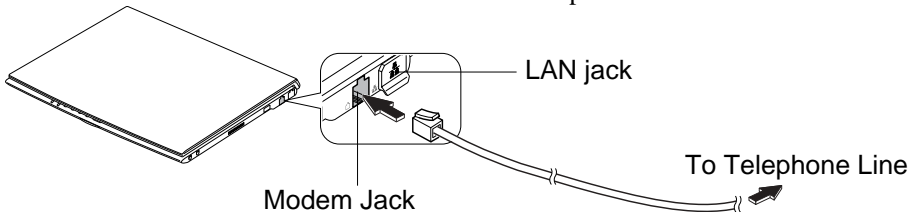

5. Turn on the computer.



*Connect the modem to the telephone line directly. Do not use a distributor or alloter.*

---

## Configuring the Modem in Windows 2000

Make the necessary adjustments as shown below.

1. From the *Start* menu, select *Settings - Control Panel*.
2. Double-click the *Phone and Modem Options* icon.
3. Select *New Location* and click *Edit*.
4. Type in the details about your location and dialing properties and click *OK*.
5. Even after you set one dialing property, you can make another new dialing property by clicking *New ...* and typing a suitable name in *Location name*.



## Internet Connection

Windows 2000 has a special *Internet Connection Wizard* to help you to connect to the Internet with ease. Simply double-click on the *Connect to the Internet* icon on the Windows desktop. If you plan on connecting to the Internet by using the modem to dial an Internet Service Provider (ISP), have your account information and dial-up number ready before you begin the *Internet Connection Wizard*.

## Dial-Up Networking

To create another dial-up networking accounts:

1. On the Windows desktop, double-click *My Computer* icon.
2. Click *Network and Dial-up Connections*.
3. Double-click *Make New Connection*.
4. Follow the instruction of the *Network Connection Wizard* dialog box to create a new account.

## Hyper Terminal and Phone Dialer

You can find these applications by opening the *Start* menu and selecting *Programs-Accessories- Communications. HyperTerminal* lets you connect to other computer terminals, for example, Bulletin Boards. *Phone Dialer* lets you store and dial numbers for quick access.

## Modem Settings

The settings for your modem are pre-installed in the Windows 2000 installed on your computer. In normal circumstances you do not have to make changes to the modem settings. If you need to make changes, follow this procedure:

1. From the *Start* menu, select *Settings - Control Panel*.
2. Double-click *Phone and Modem Options* icon.
3. Use the *Modems* and *Advanced* tabs to display the settings of your modem and make changes if necessary.

---

## Configuring the Modem in Windows XP Professional

### Modem Configuration

When you use the modem first time, you must type your location's information.

1. Click *start - Control Panel*.

2. Click *Printers and Other Hardware*; then, *Phone and Modem Options*. If Classic view is selected, double-click *Phone and Modem Options* icon.
3. In *Location Information* dialog box, select your country, type your area code, etc., and select your dial type; then, click *OK*.

Next time you click or double-click *Phone and Modem Options*, *Phone and Modem Options* dialog box appears. You can find the information you set in the above steps in *My Location* of *Dialing Rules* tab.

You can change the settings or make a new location by clicking *New...* or *Edit ...*

## Internet Connection

Windows XP Professional has a special Internet Connection Wizard to help you to connect to the Internet with ease. Click *start – Control Panel*. Click *Network and Internet Connections*; then, *Network Connections*. If Classic view is selected, double-click *Network Connections* icon. In *Network Connections* dialog box, click *Create a new connection* of *Network Tasks*. When the *New Connection Wizard* dialog box appears, follow the instructions on the screen. If you plan on connecting to the Internet by using the modem to dial an Internet Service Provider (ISP), have your account information and dial-up number ready before you begin the wizard. Once you set your connection, you can see or edit the connection status by double-clicking the icon appearing *Dial-up* of *Network Connections* dialog box.

---

## Power Management

To use communication software, you may have to disable power management. See *Disabling Power Management* in Chapter 3.



- See also the manual or online help of the software you are using.
- Within the communications software you are using, set the COM port of the built-in modem to COM3.
- Do not enter System standby/hibernate while using communication software.
- The communication speed may vary depending on the traffic, local telecommunications infrastructure, and ISP (Internet Service Provider) infrastructure.
- Before commencing with fax communication, it is recommended that you exit other application programs.

---

# LAN unit

---

You can connect to a LAN (Local Area Network) with the 100 Base-TX/10 Base-T LAN unit on your computer. To activate the LAN unit, perform the following steps.



*Use a category 3 or a category 5 LAN cable when connecting to 10 BASE-T LAN, and the category 5 only when connecting to 100 BASE-TX LAN.*

---

## Connect your computer to LAN

1. Turn off the computer.
2. If your computer is provided with the LAN cable, go to the step 4. If with the core for a LAN cable, go to the next step.
3. Attach the provided core to one end of your LAN cable. Insert the cable into the core and close the core until it clicks.

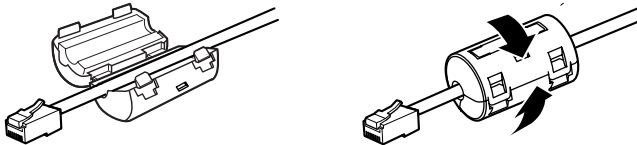

4. Remove the cover of the LAN jack on the right side of your computer.

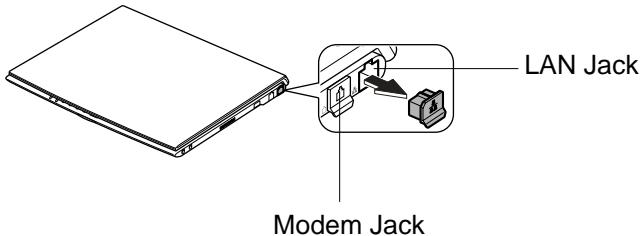

5. Connect the core end of the LAN cable into the LAN jack.



*Do not connect the LAN cable to the modem jack next to the LAN jack. It will damage the LAN cable and the modem jack.*

---

6. Connect the other end of the LAN cable into the network hub.

---

## Configuring the LAN Unit in Windows 2000

1. Turn on the computer.
2. On the Windows desktop, double-click *My Computer* icon.
3. Click *Network and Dial-up Connections*.
4. Right-click *Local Area Connection*.
5. From the pull-down menu, click *Properties*.
6. In the *Local Area Connection Properties* dialog box, set fields according to your network status. Refer to your network administrator.



*Attach the provided core to your LAN cable to insure compliance with requirements of EMC regulations for computing equipment. If your computer is provided with a LAN cable, always use that LAN cable. If your LAN cable has no core attached, please attach the provided core before use.*

If you cannot access the network,

1. From the *Start* menu, select *Settings - Control Panel*.
2. Double-click *System* icon.
3. Click *Hardware* tab; then, *Device Manager...* button.
4. Double-click *Network adapters*; then, *Realtek RTL8139 xxxxx*.
5. Click *Advanced* tab, and select *Link Speed/Duplex Mode* in *Property:* and select an appropriate value in *Value:*.
6. Click *OK* and close *Device Manager* window.
7. Click *OK* and close *Control Panel* window.

---

## Configuring the LAN Unit in Windows XP Professional

1. Click *start - Control Panel*.
2. Click *Network and Internet Connections*; then, *Network Connections*. If Classic view is selected, double-click *Network Connections* icon. Set the network setting according to the instruction of your network administrator.



*Attach the provided core to your LAN cable to insure compliance with requirements of EMC regulations for computing equipment. If your computer is provided with a LAN cable, always use that LAN cable. If your LAN cable has no core attached, please attach the provided core before use.*

If you cannot access the network,

1. Click *start - Control Panel*.
2. Click *Performance and Maintenance*; then, *System*. If Classic view is selected, double-click *System* icon.
3. Click *Hardware* tab; then, *Device Manager*.
4. Double-click *Network adapters*, then, *Realtek RTL8139 xxxxx*.
5. Click *Advanced* tab, and select *Link Speed/Duplex Mode* in *Property*: and select an appropriate value in *Value*..
6. Click *OK* and close *Device Manager* window.
7. Click *OK*.
8. Close *Control Panel* window.



## *Setup Utility*

This chapter describes how to run the Setup Utility to change settings on your computer.

---

### **Running the Setup Utility**

---

With the Setup Utility, you can customize the system configuration information, such as time and date, port assignments, or passwords. The information you have specified is saved in a special area called CMOS RAM, which the system reads every time you turn on the computer. Your computer is shipped from the factory with the appropriate setting of the Setup Utility. Leave it as default in normal use.

---

#### **Contents of the Setup Utility**



The Setup Utility consists of four menu pages, as follows:



- **Main:** Configures basic setting
- **Advanced:** Configures device interface (I/O ports, etc.)
- **Security:** Sets Passwords
- **Exit:** Exits the Setup Utility or returns to the default values

---

## Entering and Exiting the Setup Utility

1. Turn on the computer.
2. When *<F2>* to enter *SETUP* appears, press **F2**.
3. Change to the desired settings.

 or  key : Selects the menu

 or  key : Selects the item

**Minus** or **Space** key : Changes the value.

In the item with  mark, press **Enter** to open sub menu. Press **Esc** to close the sub menu and return to the previous menu.

4. Select *Exit*.
5. Select one of the exit methods, and press **Enter**.
6. Confirm the message and press **Enter** again. The system restarts.



*When the Setup Utility is opened, power management does not work. Do not close the display cover.*



---

# Main Menu

---

**System Time** defines the system time, using the format *hour:minute:second* (24-hour format). Use **Tab** key to move the cursor, and minus key or space bar to change numerals.

**System Date** defines the system date, using the format *month/day/year*. Use **Tab** key to move the cursor, and minus key or space bar to change numerals.

**Hard Disk Type** shows the type of the hard disk of your computer. Press **Enter** to show the details.

**Boot Sequence** specifies where the system boots from. Press **Enter** to open the sub menu. The system boots from the drive at the top of the list. If the system cannot find the drive, it will boot from the second one; then, third one. Use arrow keys to select the drive you want to move; then, use minus key or space bar to move it up and down.

**Internal NumLock** defines whether the numlock keys of the built-in keyboard are always disabled or not. (Num lock indicator will turn when **Fn+NumLk** are pressed regardless of this setting. An external keyboard will be numlocked if connected. )

**Memory Cache** defines whether the primary cache or the secondary cache is enabled or disabled.

**USB Emulation** defines whether USB devices can be used in MS-DOS mode.

**QuickBoot Mode** defines whether the system skips the check of the internal memory while booting, to shorten the boot time.

**Quiet Boot** defines whether the SHARP logo appears on the screen while booting.

**System Memory** shows the volume of the conventional memory used in MS-DOS. Always set to 640KB.

**Extended Memory** shows the volume of the extended memory more than 1MB.

**BIOS Version** shows the BIOS version of the system.

**EC/KBC Version** shows the EC or keyboard controller version of the system.

---

## Advanced Menu

---

**Serial port A** sets the RS-232C serial port, selecting the base I/O address. *Enabled* means that you can set the item by yourself. *Auto* means that the item is automatically assigned. *Disabled* means that you cannot use the port.

**Parallel port** sets the printer port, selecting the LPT port mode and the base I/O address. *Enabled* means that you can set the items by yourself. *Auto* means the *Mode* can be selected (*Bi-directional*, *ECP* (Extended Capabilities Port mode), *EPP* (Enhanced Parallel Port mode) or *Output only*). *Disabled* means that you cannot use the port.

**Internal Pointing Device** enables or disables the built-in glide pad.

**Resolution Expansion** defines whether the screen is expanded when the resolution is 640x480 or 800x600. *Enabled* means that the screen is expanded.

**Plug&Play O/S** enables or disables plug & play function.

**Large Disk Access Mode** normally has to be as default, *DOS*. If you install other operating system such as UNIX, you may have to change the value to *Other*.

---

# Security Menu

---

**Set Supervisor Password** defines the supervisor password (up to eight characters). See the next section about the supervisor password.

**Set User Password** defines the user password (up to eight characters). See the next section about the user password.



*If you lose your password, you will be unable to access the computer or change the configuration. Make sure to select a password you will never forget, or write it down and protect it in a secure place. Otherwise, you will have to contact your dealer for assistance.*

---

**Password on boot** defines whether you have to type the password for booting the computer.

**Hard Disk boot Sector** defines whether the boot sector of the hard disk is write-protected. When formatting the hard disk or reinstalling software, set to *Normal*.

---

## Supervisor and User Password

Setting a password will protect your computer against unauthorized access. Once a password is set, the system requires the password when entering to the Setup Utility. And if *Password on boot* is enabled, the system will require a password when the computer is turned on.



*If you enter a wrong password three times, the message System Disabled appears. Press the power button to shut down the computer, and after 10 seconds, press the power button to turn it on again.*

Your computer supports two different levels of password security: Supervisor password and User password. You cannot set a user password unless you have set a supervisor password. If you share the computer with others, we recommend that you set both the supervisor and the user password, and let others know the user password only.

If you type the user password when you enter the Setup Utility, you can change *System Time* and *System Date* of the *Main* menu, and *Set User Password* of the *Security* menu only.

---

## Setting the Password

1. In the *Security* menu of the Setup Utility, select *Set Supervisor Password* or *Set User Password* and press **Enter**.
2. Type your password (up to eight characters), and press **Enter**.
3. Type the same password again, and press **Enter** twice.
4. Select *Exit* menu and confirm *Exit Saving Changes* is highlighted; then press **Enter**.
5. Confirm *Yes* is highlighted and press **Enter**. The system restarts.

---

## Changing the Password

1. In the *Security* menu of the Setup Utility, select *Set Supervisor Password* or *Set User Password* and press **Enter**.
2. Type your current password, and press **Enter**.
3. Type your new password, and press **Enter**.
4. Type your new password again, and press **Enter** twice.
5. Select *Exit* menu and confirm *Exit Saving Changes* is highlighted; then press **Enter**.
6. Confirm *Yes* is highlighted and press **Enter**. The system restarts.

---

## Deleting the Password

1. In the *Security* menu of the Setup Utility, select *Set Supervisor Password* or *Set User Password* and press **Enter**.
2. Type your current password, and press **Enter**.
3. Without typing any characters, press **Enter**.
4. Press **Enter** twice.
5. Select *Exit* menu and confirm *Exit Saving Changes* is highlighted; then press **Enter**.
6. Confirm *Yes* is highlighted and press **Enter**. The system restarts.

---

# Exit Menu

---

**Exit Saving Changes** saves the settings you have changed and exits the Setup Utility.

**Exit Discarding Changes** exits the Setup Utility without saving the settings you have changed.

**Load Setup Defaults** returns the values of all items to the default. To exit, select one of the above items.

**Discard Changes** returns the values of all items to the values you last saved. To exit, select one of the above two items.

**Save Changes** saves the settings you have changed. To exit, select one of the above two items.



# Appendixes

The appendixes contain additional information on the use and care of your computer.

---

## Converting File Format

---

The C: drive of your computer is formatted with FAT 32 when shipped from the factory or after re-installation. The drive can be formatted with NTFS by following the instructions below:

### Converting to NTFS Format



*Once formatted with NTFS, it cannot be re-formatted again. Re-install the system if you want the drive formatted with FAT32.*

---

#### In Windows 2000

1. Log on to the computer with the name of the administrator.
2. From the *Start* menu, select *Programs – Accessories – Command Prompt*.
3. Type `CONVERT_C: _/FS :NTFS`, and press **Enter**.
4. Type the volume label of your computer and press **Enter**. You can see the volume label of the C: drive by double-clicking *My Computer*.
5. Type **Y** and press **Enter**.
6. Type `Exit` and press **Enter**.
7. From the *Start* menu, select *Shut Down...*
8. Select *Restart* and click *OK*. The system restarts and the drive will be converted to NTFS.

#### In Windows XP Professional

1. Log on to the computer with the name of the administrator.
2. From the *start* menu, select *All Programs – Accessories – Command Prompt*.
3. Type `CONVERT_C: _/FS :NTFS`, and press **Enter**.
4. Type the volume label of your computer and press **Enter**. You can see the volume label of the C: drive by clicking *My Computer* from the *start* menu.

5. Type **Y** and press **Enter**.
6. Type **Y** and press **Enter** again.
7. Type **Exit** and press **Enter**.
8. From the *start* menu, select *Turn Off Computer*.
9. Select *Restart* and click *OK*. The system restarts and the drive will be converted to NTFS.

## Setting Security for NTFS Drive

### In Windows 2000

1. Follow the steps 1 and 2 of the above Windows 2000 section.
2. Type:  
SECEDIT\_/CONFIGURE\_/DB\_C:\WINNT\TEMP.MDB\_/CFG\_C:\WINNT\INF\DEFLTWK.INF\_/AREAS\_FILESTORE, and press **Enter**.
3. If you see the message *Task is completed successfully*, type **Exit** and press **Enter**.

### In Windows XP Professional

1. Follow the steps 1 and 2 of the above Windows XP Professional section.
2. Type:  
SECEDIT\_/CONFIGURE\_/DB\_C:\WINDOWS\TEMP.MDB\_/CFG\_C:\WINDOWS\INF\DEFLTWK.INF\_/AREAS\_FILESTORE, and press **Enter**.
3. If you see the message *Task is completed successfully*, type **Exit** and press **Enter**.

---

# Maintenance and Care

---

This appendix provides you with information on how to maintain the computer in excellent working condition.

---

## Cleaning the Computer

### Cabinet

Apply a small amount of mild cleaning solution to a dry, lint-free cloth and wipe the cabinet with the cloth.





- *Never clean the computer while it is powered on.*
  - *Do not use alcohol, benzene, thinner or other strong chemical agents that may damage the cabinet.*
- 

## **Screen**

The surface of the screen may become smeared and accumulate dust during use. Avoid touching the screen with your fingers when using the system. Gently wipe the surface of the screen with a soft cloth that has been dipped in a mild detergent solution and squeezed dry.

## **Glide Pad**

Wipe the glide pad with a soft, dry cloth.

## **Ventilation Openings**

Dust on the ventilation openings may cause overheating of the computer. Wipe the ventilation openings with a soft, dry cloth.

---

## **Traveling with the Computer**

This computer is designed for portability. For safety and convenience when traveling, please follow these guidelines.

- Before traveling, back up your data on floppy disks or other external media.
- Do not travel with an optional external floppy disk drive unit, an optional external CD-ROM drive or an optional port bar connected.
- Do not carry the computer powered on. This may result in loss of data and/or damage to the hard disk drive.
- Make sure the display cover is closed before traveling. Otherwise the cover may be opened unawares, and the display or the keyboard will be damaged.
- If you carry the computer in a bag, try to avoid unnecessary pressure, caused by the stuff of the bag, to the computer.
- Disconnect the AC adapter from the computer.
- Fully charge the standard battery pack and bring the AC adapter and the AC power cord.
- Avoid sudden shocks or extreme vibration.

---

# Re-installation Instructions

---

To recover your hard disk, you will use PowerQuest®EasyRestore™. Before starting re-installation, read the following End User License Agreement first.

## **PowerQuest(R) EasyRestore (TM) End User License Agreement**

IMPORTANT: Read this before using your copy of PowerQuest software.

This document is a legal agreement between you, the "end user," and PowerQuest Corporation. Use of the software indicates your acceptance of these terms. As used in this License Agreement, the term "Software" means the EasyRestore software included on the CD provided with this License Agreement.

1. **PROPRIETARY RIGHTS.** The Software is a proprietary product of PowerQuest Corporation ("PowerQuest") or its licensors and is protected under U.S. copyright laws and international treaty provisions. Ownership of the Software and all copies, modifications, and merged portions thereof shall at all times remain with PowerQuest or its licensors.
2. **GRANT OF LICENSE.** The Software is being licensed to you, which means you have the right to use the Software only in accordance with this License Agreement. The Software contains pre-installed software for disaster recovery purposes. The Software is only authorized for distribution together with a specific computer. This License authorizes you to use the Software for disaster recovery purposes only, to restore the hard disk image contained on the CD to the computer with which the CD and Software were originally shipped.
3. **NONPERMITTED USES.** Without the express permission of PowerQuest, you may not (a) use, copy, modify, alter, or transfer, electronically or otherwise, the Software or documentation except as expressly permitted in this License Agreement, or (b) translate, reverse program, disassemble, decompile, or otherwise reverse engineer the Software.
4. **TECHNICAL SUPPORT.** PowerQuest is NOT responsible to provide technical support. Any and all technical support questions, regarding the Software, should be referred to the place of purchase.
5. **U.S. GOVERNMENT RESTRICTED RIGHTS.** If you are acquiring the Software on behalf of any unit or agency of the United States Government, the following provision applies: It is acknowledged that the Software and the documentation were developed at private expense and that no part is in the public domain and that the Software and documentation are provided with RESTRICTED RIGHTS. Use,

duplication, or disclosure by the Government is subject to restrictions as set forth in subparagraph (c)(1)(ii) of the Rights in Technical Data and Computer Software clause at DFARS 252.227-7013 or subparagraphs (c)(1) and (2) of the Commercial Computer Software-Restricted Rights at 48 CFR 52.227-19, as applicable. Contractor/manufacturer is PowerQuest Corporation/P.O. Box 1911/Orem, UT 84059.

6. NO WARRANTY. The Software is being provided to you AS IS. PowerQuest does not warrant the Software to end users. If the Software fails to perform substantially in accordance with the documentation provided to your hardware supplier, PowerQuest will repair or replace the copy of the Software provided to your hardware supplier and will authorize your hardware supplier to provide such repaired or replaced Software to you without charge.

7. LIMITATION OF LIABILITY. NEITHER POWERQUEST NOR ITS SUPPLIERS SHALL IN ANY EVENT BE LIABLE FOR ANY DAMAGES WHATSOEVER ARISING OUT OF OR RELATED TO THE USE OF OR INABILITY TO USE THE SOFTWARE, INCLUDING BUT NOT LIMITED TO DIRECT, INDIRECT, SPECIAL, INCIDENTAL, OR CONSEQUENTIAL DAMAGES, AND DAMAGES FOR LOSS OF BUSINESS PROFITS, BUSINESS INTERRUPTION, LOSS OF BUSINESS INFORMATION, OR OTHER PECUNIARY LOSS, EVEN IF POWERQUEST CORPORATION HAS BEEN ADVISED OF THE POSSIBILITY OF SUCH DAMAGES, WHETHER SUCH LIABILITY IS BASED ON CONTRACT, TORT, WARRANTY, OR ANY OTHER LEGAL OR EQUITABLE GROUNDS. BECAUSE SOME STATES DO NOT ALLOW THE EXCLUSION OR LIMITATION OF LIABILITY FOR CONSEQUENTIAL OR INCIDENTAL DAMAGES, THE ABOVE LIMITATION MAY NOT APPLY TO YOU.

8. NO WAIVER. Any failure by either party to this agreement to enforce a specific part of the agreement in a specific situation is not a waiver of rights under the agreement. The party may still enforce the rest of the agreement in that situation and may still enforce some or all of the agreement in other situations.

9. This License Agreement constitutes the entire agreement between you and PowerQuest pertaining to its subject matter. This License Agreement is governed by the laws of the State of Utah. Any litigation arising from this license will be pursued only in the state or federal courts located in the State of Utah.

Copyright 1994-2002, PowerQuest Corporation. All rights reserved. U.S. Patents 5,675,769; 5,706,472; and 5,930,831; other patents pending in the U.S.A. and elsewhere. PowerQuest is a registered trademark and EasyRestore is a trademark of PowerQuest Corporation.

---

## Preparation for Re-installation

You can format the hard disk and re-install the preinstalled software with the recovery CD-ROMs, and set the status of your computer to the same configuration as you used for the first time. The following items are necessary for re-installation:

- Optional external CD-ROM drive unit (CE-CD05)
- Product Recovery CD-ROM disks
- Operation Manual



- *It will take about 50 minutes to complete the re-installation. The time depends on the operating system you are installing.*
- *It takes about ten seconds for the system to recognize a CD-ROM. If you operate too quickly, an error message may appear. In this case, return to the first step and repeat the installation.*
- *Use the Product Recovery CD-ROMs only for your computer.*
- *The Product Recovery CD-ROMs are not for sale. Keep them in a secure place.*

---

## Backing up the data

Before formatting the hard disk, you should back up your data. For details on how to back up your data, see the Windows Online Help.



*Although the pointer may be shown on the screen, never touch the keyboard or the mouse during recovery except when the message prompts you to. If you touch them, the re-installation will be canceled. In this case, not only C: drive but also D:drive will be formatted.*

---

## Selecting the way to recover your system

Your computer has two drives(C: and D:) when it was shipped from the factory. You can select the way to recover your system.

- *Recovers C: drive only. (Recommended)*  
This process will format C: drive only and recover C: drive to the same status as shipped from the factory. Nothing will be performed to D: drive. The volume of the drives will not be changed and will keep current one.
- *Recovers both C: and D: drive.*

This process will format both C: and D: drives, and contents of the hard disk will be restored to its original state in C: drive. The volume of the drives will be back to the same as you used for the first time.

- *Formats hard disk and creates new partition.*

This process will format whole hard disk drive and create new partition. You can select the volume of C: and D: drives. The contents of the hard disk will be restored to its original state in C: drive.

---

## Formatting the drives and re-installing Windows

1. Make sure the computer is turned off.
2. If any peripheral devices, except the optional external CD-ROM drive unit (CE-CD05), are connected to your computer, disconnect them.
3. Turn on the computer.
4. When the message *Press <F2> to enter SETUP* appears, press **F2**. The Setup Utility opens.
5. Insert the Product Recovery CD-ROM disk 1 into the CD-ROM drive.
6. In the *Exit* menu, select *Load Setup Defaults*; then, press **Enter** twice.
7. In *Boot Sequence* of the *Main* menu, set *CD-ROM Drive* to the top of the list; then, press **ESC**.
8. In the *Exit* menu, confirm *Exit Saving Changes* is highlighted and press **Enter** twice.
9. Read the message on the screen, and select the operating system which you had selected for the first time you use the computer; then, press **Enter**.



*You cannot change the operating system from the first choice.*

- 
10. Read the message on the screen, and select the way to recover your system; then, press **Enter**.
  11. Read the message and select *Continue*; then, press **Enter**.
  12. Read the message and select *Continue* again; then, press **Enter**.
  13. If you see the message asking you to insert the Product Recovery CD-ROM disk 2, remove the disk 1 and insert the disk 2; then, press **Enter**.
  14. If you see the message asking you to insert the Product Recovery CD-ROM disk 3, remove the disk 2 and insert the disk 3; then, press **Enter**.

15. If you see the message *The Operating System has been recovered successfully*, remove the Product Recovery CD-ROM disk 3. The system will restart automatically.
16. When the message *Press <F2> to enter SETUP* appears, press **F2**. The Setup Utility opens.
17. In the *Exit* menu, select *Load Setup Defaults*; then, press **Enter** twice.
18. In the *Exit* menu, confirm *Exit Saving Changes* is highlighted and press **Enter** twice. The system restarts.
19. Set up Windows, following the instructions on the screen. When you finish the setup, the recovery is completed.

# Specifications

Parts		Specifications	
CPU		Ultra Low Voltage Mobile Intel®Pentium® III processor featuring Intel® SpeedStep™ Technology at 750/350MHz -M	
Primary cache		32KB (Integrated with CPU)	
Secondary cache		512KB (Integrated with CPU)	
ROM		Including system BIOS,VGA BIOS, Plug&play compliant BIOS	
RAM	System	SDRAM 256MB (not expandable)	
	Video	4MB (Integrated with display controller)	
Display	Panel	Active Matrix (TFT) color LCD 12.1"(30.7cm)	
	Video controller	ATI Rage Mobility-M	
	Resolution/color	1024 x 768 dots/16M colors by dithering function	
Keyboard		IBM compatible keyboard	
Pointing device		Glide pad (touch-sensitive control pad with 2 buttons )	
Drive	Hard disk	IDE interface 20GB	
	Floppy disk (option/external)	USB interface 3.5", 1.44MB/720KB	
	CD-ROM (option/external)	USB interface, 6 x Speed	
PC card slot		Type II x 1 (PCMCIA 2.1 compliant) CardBus compliant	
Audio system		Monaural microphone, monaural speaker, sound system compliant with AC97 audio	
I/O ports	Audio	Audio output jack (stereo), external microphone jack	
	Others	USB port, expansion port for external display/optional port bar	
Modem		Data: 56Kbps (receive), 33.6Kbps (send), Fax: 14.4Kbps	
LAN		100 BASE-TX/10 BASE-T	
Power	AC adapter	100-240V, 50-60 Hz	
	Battery	Rechargeable lithium ion battery	
	Battery life	Approximately 3 hours (standard battery pack only) Approximately 9 hours (high capacity battery pack (CE-BL18) only) *Battery life varies depending on usage *The standard battery pack and the high capacity battery pack cannot be used simultaneously	
		Battery charging time *Charging time varies depending on usage	Standard battery pack
High capacity battery pack	Turned off/hibernation: about 3.5 hours Turned on: charging time may vary depending on the usage		
Dimensions		11.1" wide x 9.13" deep x 0.65" (min.)/0.77" (max.) high (282mm x 232mm x 16.6mm (min.)/19.6mm (max.)) *No protrusion is included.	
Weights		About 2.91 lbs (1.32 kg)	
Operating environment	Temperature	50°F to 95°F (10°C to 35°C)	
	Humidity	20% to 80% (non-condensation)	

---

**Options (may not be available in some countries)**

Standard Battery Pack	CE-BL17
High Capacity Battery Pack	CE-BL18
External CD-ROM Drive	CE-CD05
External Floppy Disk Drive	CE-FD04 / CE-FD05
AC Adapter	CE-MU01V
Port Bar	CE-PB01



# Troubleshooting

This chapter describes how to troubleshoot computer problems.

---

## Common Problems

Problems with your computer can be caused by something as minor as an unplugged power cord or as major as a damaged hard disk drive. The information in this troubleshooting section is designed to help you find and solve minor problems. If you still have a problem after trying all the suggested remedies in this chapter, contact your dealer.

The problems that you might encounter can be divided into two basic categories: hardware and software. Hardware problems can be further divided into being of an electrical or a mechanical nature. You will know you have a hardware problem if, for example, the screen is blank, or the computer cannot recognize the disk drives.

Software problems can occur at several levels. Both your operating system and your software application programs are capable of generating errors and error messages. If you encounter a software error, try to determine if the error message is from your operating system or from an application program, and refer to the appropriate manual for possible remedies.

You can also refer to the Windows manual or Windows Help program to solve the problem. To access the Help program, select *Help* from the *Start* menu. It also gives you Troubleshooting tips and an Index.

Successful troubleshooting is the result of careful observation, deductive reasoning, and an organized approach to solving the problem. If you encounter a problem, begin by performing a careful visual inspection. Check the exterior of the computer first. If no lights are displayed, check the battery charge or power outlet, the plug and power cord, and any power switches that may affect your computer. If the computer has been connected to any peripheral devices, look for loose or disconnected cables. You may also need to check the fuses and breakers in your electric box. A few common problems and suggested solutions are presented in the examples which follow.

---

## Trouble when Starting

### **Question: Why doesn't the power indicator or the battery indicator turn on?**

- Make sure the AC adapter is correctly connected to the AC adapter jack of your computer.
- Make sure the AC power cable is correctly connected to a live wall outlet. Connect another electric equipment to the wall outlet and check whether it is live or not.
- Make sure the battery pack is correctly installed and charged.
- If the battery pack is discharged, connect the AC adapter.
- If all the steps above failed, follow the instructions on *Why doesn't the keyboard or the glide pad function?*

### **Question: Why do I get the message *Invalid system disk*?**

- You may have inserted a non-bootable disk in the optional external floppy disk drive unit (either a defective disk or one without an installed operating system). Remove the disk.

### **Question: Why can't I boot from the floppy disk?**

- Make sure that the optional external floppy disk drive unit is correctly connected to the computer.
- Check whether the floppy disk set to the optional external floppy disk drive unit contains a system disk.
- Check whether *Floppy Disk Drive* is set to the first in *Boot Sequence* of the *Main* menu of the Setup Utility.

### **Question: Why do I get the message *Press<F1> to resume, <F2> to setup*?**

- The setting of the Setup Utility is deleted. Run the Setup Utility and get default value of the Setup Utility. Be sure to set the date and time correctly.

### **Question: Why do I get the message *Operating system not found*?**

- Run the Setup Utility and get default value of the Setup Utility. Be sure to set the date and time correctly.

---

## **Trouble with Display**

See also the Display section in Chapter 4.

### **Question: Why is the screen blank?**

- Press any key to see if any power management feature has turned off the screen to save power.
- See the power indicator to check whether the computer is turned on.
- If you are using a battery pack, make sure it is correctly installed and has a charge remaining.
- Make sure the LCD screen is selected as the display by pressing **Fn+F5**.
- Check whether the display is on by pressing **Fn+F11**.
- If you still have the problem after trying the above, follow the steps in *Why doesn't the keyboard or the glide pad function?*

### **Question: Why does the external monitor display nothing or the image on it distorted?**

- Confirm the monitor is turned on.
- Confirm the monitor is connected correctly.
- Make sure an external monitor is selected as the display by pressing **Fn+F5**.
- If you use **Fn +F5** to change the display, the image may be distorted. Press **Fn + F5** again to return the previous display and use *Display Properties* dialog box to change it again.
- Make sure the value of the *Screen area* (Windows 2000) or *Screen resolution* (Windows XP Professional) in the *Settings* tab of the *Display Properties* is lower than the resolution of the CRT monitor.
- Make sure the CRT is not near any electric devices having strong magnetic fields such as a TV set or radio.
- Do not share an outlet with a TV set or radio.

### **Question: Why can't I change the display with Fn + F5 keys?**

- When playing the animation or game, **Fn + F5** key combination may not work. Close the currently running application.
- Use *Display Properties* dialog box to change it.

---

## **Trouble with Keyboard/Glide Pad**

### **Question: Why doesn't the keyboard or the glide pad function?**

- Follow the steps below:
  1. Press **Ctrl+Alt+Delete** and select *Log Off...* or *Shut Down...* (Windows 2000). Press **Ctrl+Alt+Delete** and select *Users* tab of *Windows Task Manager* dialog box. Click *Disconnect* or *Logoff*; then, *Yes* (Windows XP Professional).
  2. If step 1 does not work, press the power switch for more than four seconds to turn off the system. Ten seconds later, turn the computer on.
  3. If you still cannot turn off the system with the power switch, press the reset switch on the bottom of your computer to turn off the system (refer to page 2-3). Ten seconds later, turn on the computer by pressing the power switch.

### **Question: Why does the glide pad malfunction?**

- The pad of the glide pad or your palm may be moist or dirty and greasy. Wipe the glide pad with a soft, dry cloth.

---

## **Trouble with Floppy Disks**

### **Question: Why can't I use a floppy disk?**

- Confirm the optional external floppy disk drive unit is correctly connected.
- Confirm the floppy disk is inserted correctly.
- Confirm the drive or file name is correct.
- The floppy disk may not be formatted or could be corrupted. Format the disk or use another disk.
- If you cannot write to a floppy disk, the disk may be write-protected. Eject the disk and ensure that the write-protect tab covers the detection hole.
- If you cannot write to a floppy disk, the disk may be full. Use another disk.

---

## Trouble with the Hard Disk

### **Question: Why can't I read or write data to/from the hard disk?**

- Confirm the drive and file names are correct.
- Confirm the hard disk has sufficient free space.

---

## Trouble with the CD

### **Question: If the message requiring Windows 2000 CD-ROM appears?**

- Type C: \i386 in *Copy files from:* dialog box.

### **Question: Why can't I read data from a compact disc or play files?**

- Confirm the optional external CD-ROM drive unit is correctly connected to the computer.
- Confirm the CD is inserted correctly.
- Confirm the drive and file names are correct.
- Confirm the CD is not stained or scratched.
- Confirm the CD or files are supported.

---

## Trouble with Communication

### **Question: Why can't I communicate through the built-in modem?**

- Confirm the telephone line is properly connected to the modem jack.
- Confirm the dial setting (plus or tone) of Windows or communication software is matched with the telephone line.
- Confirm the country/region setting is appropriate.
- Confirm the network configuration is appropriate.
- Confirm the user name or password is correct.
- Confirm the COM port in the communication software is set appropriately.
- Turn off the power management in the Windows.
- If an unusual device is attached to the line you are connecting to, the modem may not function properly. Remove the device or contact the dealer of the device.

- If connected to a PBX, consult the PBX maintenance staff or its service company. If the electric characteristics of your PBX are different from those of a regular analog line, the modem will not function properly. If you connect the modem to a digital PBX, both the modem and the PBX may be damaged.

**Question: Why is the access speed so slow?**

- Close the applications currently opened.
- Try to connect another ISP (Internet Service Provider), or try to connect in some other time.

**Question: Why can't I access the LAN?**

- Confirm the cable is properly connected to the LAN jack and the network hub.
- Confirm the network configuration is appropriate.
- Confirm the user name or password is correct.

---

## Trouble with Peripherals

**Question: Why don't peripheral devices function?**

- Confirm they are correctly connected to your computer.
- Confirm they are Windows 2000 or XP Professional compliant.
- Confirm drivers necessary for the devices are installed.
- There may not be a free IRQ (Interrupt). Free up an IRQ from a built-in device (Windows 2000 only).

**Question: Why can't I print?**

- Make sure the printer is turned on.
- Check whether the computer and the printer are connected correctly.
- Check whether the printer is ready to print.
- Check whether the printer has enough paper.
- Check whether the printer driver is installed.
- From the *Start* menu, select *Settings - Printers* to confirm your printer is installed there. If not, double-click *Add Printer* to install your printer (Windows 2000). From the *start* menu, select *Printers and Faxes* to confirm your printer is installed there. If not, click *Add a printer* of *Printer Tasks* to install your printer (Windows XP Professional).

- See also the Windows Help.

### **Question: Why don't peripheral devices function correctly?**

- Set *System standby* and *System hibernates* to *Never* in *Power Options Properties* dialog box. If this does not work, set *Turn off hard disks* to *Never*.
- Confirm they are Windows 2000 or Windows XP Professional compliant.
- Confirm drivers necessary for the devices are installed.
- There may not be a free IRQ (Interrupt). Free up an IRQ from a built-in device (Windows 2000 only).

---

## **Other Troubles**

### **Question: Why is the battery pack discharged so quickly?**

- Initialize the battery pack.

### **Question: Why is the date and/or time incorrect?**

- Correct the date and time in Windows. Double-click the time appearing on the taskbar and set them in *Date/Time Properties*(Windows 2000) or *Date and Time Properties*(Windows XP Professional) dialog box.

### **Question: Why can't I use a hardware device?**

- Make sure the hardware device is not crossed out with an X mark using the following procedure.  
(Windows 2000)
  1. From the *Start* menu, select *Settings – Control Panel*.
  2. Double-click *System* icon.
  3. Click *Hardware* tab; then, *Device Manager...*
  4. Double-click the device you cannot use.
  5. Confirm *Use this device (enable)* appears in *Device usage*.

(Windows XP Professional)

1. Click *start– Control Panel*.
2. Click *Performance and Maintenance*; then, *System*.  
If *Category* view is selected, double-click *System* icon.
3. Click *Hardware* tab; then, *Device Manager*.
4. Double-click the device you cannot use.

5. Confirm *Use this device (enable)* appears in *Device usage*.

**Question: Why can't I produce sound?**

- Press **Fn + F4** to increase the output volume.
- Double-click the speaker symbol on the taskbar and check the Windows volume.

**Question: Why can't I turn off the computer?**

- Follow the instructions on *Why doesn't the keyboard or the glide pad function?*

**Question: Why the computer is so hot?**

- When charging the battery pack, its surrounding area or the front of the keyboard may become hot, but this is not a problem.

**Question: Why can't I record the sound from the microphone?**

- Follow the instructions below:
  1. Double-click the speaker icon on the taskbar.
  2. Click *Options* and select *Properties*.
  3. Select *Recording* in *Adjust volume for*; then click *OK*.
  4. Confirm *Select* is checked in *Microphone* of *Recording Control* dialog box.
  5. Close *Recording Control* dialog box.



# Index

## A

- AC adapter
  - connecting, 1-3
  - using, 2-2
- Audio
  - connecting audio equipment, 4-15

## B

- Battery pack
  - changing, 3-4
  - charging, 3-2
  - checking level, 3-2
  - conditioning, 3-4
  - indicator, 2-1, 3-3
  - low battery indication, 3-3
  - optional battery pack, 3-7

## C

- Cleaning
  - computer, A-2
  - optional CD-ROM drive unit, 4-7
- CD-ROM drive unit (external/optional)
  - connecting, 4-7
  - disconnecting, 4-10
  - mode switch, 4-10
  - troubleshooting, T-5
- CD
  - handling, 4-8
  - inserting, 4-8
  - playing, 4-10
  - removing, 4-9

## D

- Display
  - changing brightness, 2-7
  - changing number of colors, 4-13
  - changing resolution, 4-13

- switching the display, 2-6, 4-13
- troubleshooting, T-3
- turning off, 2-7

## E

- External monitor
  - connecting, 4-12
  - disconnecting, 4-13
  - switching the display, 2-6, 4-13

## F

- floppy disk
  - formatting, 4-5
  - handling, 4-3
  - inserting, 4-4
  - removing, 4-4
- Floppy disk drive unit (external/optional)
  - connecting, 4-3
  - disconnecting, 4-5
  - troubleshooting, T-4

## G

- Glide pad
  - changing configuration, 2-5
  - clicking and double-clicking, 2-5
  - drag and drop, 2-5
  - scroll, 2-5
  - troubleshooting, T-4

## H

- Hard disk drive
  - troubleshooting, T-5

## I

### Indicators

- power and battery, 2-1
- status, xvii

## K

### Keyboard

- function keys, 2-6
- special keys, 2-6
- troubleshooting, T-4
- windows keys, 2-6

## L

### LAN

- configuring, 5-6
- connecting to network, 5-5
- troubleshooting, T-6

## M

### Modem

- configuring, 5-2,3
- connecting to telephone line, 5-1
- troubleshooting, T-5

## P

### Passwords

- changing, 6-6
- deleting, 6-6
- setting, 6-6
- supervisor, 6-5
- user, 6-5

### PC cards

- ejecting, 4-19
- inserting, 4-18

### Peripherals

- audio equipment, 4-15
- connecting guidelines, 4-1
- external CD-ROM drive, 4-6
- external floppy disk drive, 4-3
- external monitor, 4-12
- headphones, 4-16
- microphone, 4-16
- PC cards, 4-17

- port bar (optional), 4-21
- printer, 4-21
- troubleshooting, T-6
- USB device, 4-17

### Port bar (optional)

- connecting, 4-21
- disconnecting, 4-22
- ports, 4-22
- using, 4-22

### Power

- choosing AC or battery, 2-1
- indicator, 2-1

### Power management

- controlling CPU speed, 3-9
- disabling, 3-13
- stopping power supply to display, 3-8
- stopping power supply to hard disk, 3-8
- system hibernate, 3-11
- system standby, 3-11

### Printer, 4-21

## R

### Resetting

- power button, 2-3
- reset switch, 2-3

## S

### Setup utility

- advanced menu, 6-4
- entering and exiting, 6-2
- exit menu, 6-7
- main menu, 6-3
- running, 6-1
- security menu, 6-5

### Speedstep technology, 3-9

### System Standby

- about, 3-11
- generating conditions, 3-12
- resuming from, 3-11

### System Hibernate

- about, 3-11
- generating conditions, 3-12
- resuming from, 3-11
- supporting, 3-11

### Status indicators, xvii

## T

### Troubleshooting

- common problems, T-1
- communications, T-5
- display, T-3
- floppy disk drive, T-4
- hard disk drive, T-5
- keyboard or glide pad, T-4
- peripherals, T-6
- reference, T-1

## U

- USB device, 4-17

## W

### Windows 2000

- changing user name, 2-8
- changing user password, 2-8
- first-time setup, 1-5
- properties dialog boxes, 1-6
- registering user, 2-8

### Windows XP Professional

- changing a password, 2-11
- deleting a password, 2-11
- first-time setup, 1-5
- properties dialog boxes, 1-6
- set a password, 2-10
- set a user account, 2-9



# SHARP CORPORATION